



UGEAR[®]

Mechanical models

**Model «Hurdy-Gurdy»
Модель «Харді Гарді»**

DEU Modell «Drehleier». FRA Modèle «Vielle à roue».
POL Model «Lira korbowa». SPA Modelo «Hurdy-Gurdy».
ITA Modello «Ghironda». TUR Model «Hurdy-Gurdy».
RUS Модель «Харди-Гарди». KOR 허디거디. CHI «论擦提琴»模型

**Assembly instructions
Інструкція зі складання**

DEU Aufbauanleitung. FRA Notice d'assemblage. POL Instrukcja montażu.
SPA Instrucciones de montaje. ITA Istruzioni di montaggio. TUR Kurulum talimatı.
RUS Инструкция по сборке. KOR 조립 설명서. CHI 装配说明书

ENG**Manual:**

Remove model parts from the hanger board as illustrated below. Careful not to break parts. If a part does not remove easily, carefully cut it out with a knife. This model is intended for self-assembly without glue. If you have difficulty installing the axles, try waxing them with a regular candle. All moving parts can also be waxed during assembly to reduce friction when operating the model.

TUR**Kurulum talimatı:**

Şemada işaretlenen parçaları tahtadan çıkarın. Kırılmamasına dikkat ediniz. Parça çıkarılmıyorsa bağlantı yerleri bıçakla kesiniz. Konstruksyon, yapıştırıcı kullanmadan yapılmaktadır. Tahta dingilini (kürdan) deliğin içine yerleştirmede zorluk çekiyorsanız önceden dingile veya parçalara mum sürünüz. Hareketli parçaların daha iyi kayması için kurulum sırasında parçalara mum sürünüz.

UKR**Інструкція зі складання:**

Витягніть з дошки позначені на схемі деталі. Намагайтеся їх не зламати. Якщо деталь не виймається, надсічіть перемички ножом. Конструкція збирається без клею. У разі виникнення труднощів з протягуванням зубочистки (вісі) в отвір потріть зубочистку об звичайну свічку. Також можна змастити свічкою всі деталі механізму, що рухаються, щоб зменшити тертя при обертанні.

RUS**Инструкция по сборке:**

Вынимайте из доски обозначенные на схеме детали. Старайтесь их не сломать. Если деталь не извлекается, надрежьте перемычки ножом. Конструкция собирается без клея. Если возникли трудности с установкой деревянной оси, перед установкой потрите детали об обычную свечу. Для лучшего скольжения смазывайте движущиеся детали механизма обычной свечой во время сборки.

DEU**Aufbauanleitung:**

Bitte die in der Zeichnung angegebenen Teile aus der Platte herausnehmen. Versuchen Sie bitte diese nicht zu brechen. Wenn sich ein Teil nicht herausnehmen lässt, schneiden Sie die Stege mit dem Messer leicht an. Das Modell wird ohne Klebstoffe zusammgebaut. Lässt sich eine Achse nur schwer in eine Öffnung einführen, reiben Sie diese mit einer Kerze etwas ein. Für besseres Gleiten schmieren Sie alle beweglichen Teile mit einer Kerze.

KOR**조립 설명:**

부품이 손상되지 않도록 주의하여 보드에서 떼어냅니다. 만약 부품이 잘 떨어지지 않으면 연결 부분을 칼로 절단 한 후 떼어내면 쉽게 떼어 낼 수 있습니다. 본 제품은 접착제가 없이 조립이 가능하도록 설계되어 있습니다. 만약 축이 잘 끼워지지 않는 경우 양초를 축에 바른 후 끼워보세요. 모든 구동 부위는 제품 구동 시 원활한 작동이 가능하도록 조립 과정에서 윤활제(양초)양초를 발라 주세요.

FRA**Notice d'assemblage:**

Faites sortir de la planche les pièces comme indiquées sur le schéma. Tâchez de ne pas les casser. Si la pièce ne sort pas, incisez les collages/fixations avec un couteau. La construction est à assembler sans colle. Si il est difficile d'introduire l'axe en bois dans l'orifice, frottez au préalable l'axe ou les pièces contre une bougie. Pour améliorer le glissement, traitez les pièces de frottement mobiles du mécanisme avec une bougie au cours d'assemblage.

CHI**装配说明**

将模型部件按插图示，从胶合板取下。小心不要损坏件。如果取下时候有难度，请用小刀小心的切割连接点。这个产品不需要胶水粘接。如果安装转轴的时候有难度，请用普通的蜡加以润滑。所有的转动部分也需要打蜡润滑。

POL**Instrukcja montażu:**

Delikatnie wyciągaj z deseczki wskazane w schemacie detale, starając się nie połamać elementów. Jeśli detal nie poddaje się, podetnij wiązadła nożem. Konstrukcje składa się bez kleju. Jeśli napotkasz trudności z instalacją drewnianej osi w otwór, potrzyj na początku oś lub detale o woskową świecę. Dla lepszego poślizgu polecano smarowanie ruchomych części mechanizmu zwykłą świecą podczas montażu.

SPA**Instrucciones de montaje:**

Saque de la tabla las piezas marcadas en el esquema. Trate de no romperlas. Si una pieza no se saca, haga una incisión. La construcción va sin pegamento. Si tiene dificultades con la instalación del eje de madera en un agujero, frote primero el eje o las piezas contra una vela. Para un mejor deslizamiento, lubrique durante el montaje las piezas móviles del mecanismo con una vela común.

ITA**Istruzioni di montaggio:**

Estrarre dal telaio i particolari indicati nello schema. Fare attenzione a non romperli. Se un particolare non si stacca, tagliare delicatamente gli elementi di collegamento con un coltello. L'assieme viene realizzato senza colla. In caso di difficoltà nell'inserimento di un perno in legno, è necessario sfregare il perno o il particolare con un po' di cera. Per uno scorrimento migliore incerare le parti mobili del meccanismo durante l'assemblaggio.

ENG Warning! UKR Увара! DEU Achtung! FRA Attention! POL Uwaga! SPA Precaución! ITA Attenzione! TUR Dikkat! RUS Внимание! KOR 주의! CHI 注意!



ENG Do not use a lighted candle! **UKR** Не підпалювати! **DEU** Nicht anzünden! **FRA** Ne pas brûler! **POL** Nie podpalać! **SPA** ¡No encender! **ITA** Non dare fuoco! **TUR** Yakmayınız! **RUS** Не поджигать! **KOR** 불이 붙은 초를 이용하지 마세요! **CHI** 请勿点燃，请勿靠近火源！



ENG Caution! Axles have sharp points! **UKR** Обережно! Гострі деталі! **DEU** Vorsicht! Spitze Teile! **FRA** Attention: certaines pièces sont pointues! **POL** Ostrożnie! Ostre części! **SPA** ¡Atención! Piezas afiladas! **ITA** Attenzione! Particolari appuntiti! **TUR** Dikkat! Keskin parçalar! **RUS** Осторожно! Острые детали! **KOR** 축의 뾰족한 부분에 주의하세요! **CHI** 舍尖锐部件！

ENG Symbols. **UKR** Умовні позначення. **DEU** Legende. **FRA** Légende. **POL** Oznaczenia umowne. **SPA** Leyenda. **ITA** Legenda. **TUR** Kararlaştırılan işaretler. **RUS** Условные обозначения. **KOR** 기호. **CHI** 图标含义



ENG Wax the part with a regular candle (rub with a candle). **UKR** Змастіть деталь звичайною свічкою (потріть об свічку). **DEU** Reiben Sie das Teil mit einer einfachen Kerze etwas ein. **FRA** Lubrifiez la pièce avec une bougie ordinaire (frottez contre la bougie). **POL** Przesmaruj zwykłą świecą. **SPA** Engrase la pieza con una vela común (frote con una vela). **ITA** Incerare il componente (Sfregare con la cera). **TUR** Parçaya sade mum sürünüz. **RUS** Смажьте деталь обычной свечкой (потрите о свечку). **KOR** 표시된 부분에 윤활을 위해 초를 칠해 주세요. **CHI** 用普通蜡烛涂抹润滑部件。

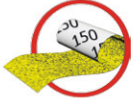
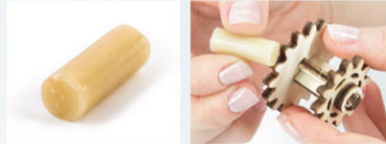

ENG Sand to remove burrs. **UKR** Видалить задирки. **DEU** Grate entfernen. **FRA** Éliminez les bavures. **POL** Usuń zadziory. **SPA** Quite las rebabas. **ITA** Togliere le bave. **TUR** Çapakları çıkartınız. **RUS** Удалите заусенцы. **KOR** 거친 부분을 다듬어 주세요. **CHI** 磨掉毛刺



ENG Rosin. Brush over with rosin. **UKR** Канифоль. Натерти поверхню канифоллю. **DEU** Kolophonium. Mit Kolophonium einreiben. **FRA** Colophane. Frotter colophane. **POL** Kalafonia. Przetrzeć kalafonią. **SPA** La colofonia. Frotar con la colofonia. **ITA** Colofonia. Spazzolare con colofonia. **TUR** Reçine. Öğütülmüş reçine. **RUS** Канифоль. Натереть поверхность канифолью. **KOR** 송진가루. 송진가루를 칠할 것. **CHI** 松香 刷过松香



ENG Do not fully press the outer parts (structural frame) together until checking for fit and alignment of internal parts. **UKR** Деякий час не притискайте сильно деталі (рамки конструкції). **DEU** Drücken Sie die Teile (die Rahmen der Konstruktion) momentan nicht stark. **FRA** Ne pas forcer sur les pièces (cadre de la construction). **POL** Tymczasowo nie dociskaj elementów (ramy konstrukcji). **SPA** No presione temporalmente con fuerza las piezas (marco de la estructura). **ITA** Non stringere provvisoriamente i componenti con forza (base della costruzione). **TUR** Bir süre için parçaları (yapı çerçevelerini) fazla sıkmayın. **RUS** Временно сильно не прижимайте детали (рамки конструкции). **KOR** 아직은 외부의 틀을 완전히 눌러서 고정하면 안됩니다. 다른 부품을 먼저 끼우세요. **CHI** 在检查内部零件的配合和对准之前，请暂时不要将外部零件（结构框架）完全压在一起。



ENG Press the parts as far as they will go. **UKR** Притисніть деталі до упору. **DEU** Drücken Sie die Teile bis zum Anschlag. **FRA** Pressez les pièces à fond. **POL** Przyciśnij element, aż do oporu. **SPA** Pulse para detener las piezas. **ITA** Stingere bene i componenti. **TUR** Parçaları sonuna kadar sıkıştırınız. **RUS** Прижмите детали до упора. **KOR** 부품을 양쪽에서 눌러서 고정해 주세요. **CHI** 用力紧密结合部件



ENG Pay attention. Check for correct orientation or positioning. **UKR** Зверніть увагу. Перевірте розташування елемента. **DEU** Bitte Beachten. Prüfen Sie die Einbaulage des Elementes. **FRA** Faites attention. Vérifiez la disposition de l'élément. **POL** Zwróć uwagę. Sprawdź lokalizację elementu. **SPA** Atención. Compruebe la situación del elemento. **ITA** Prestare attenzione. Controllare la posizione del componente. **TUR** Dikkat. Elemanın yerleşimini kontrol ediniz. **RUS** Обратите внимание. Проверьте расположение элемента. **KOR** 방향 또는 위치에 주의해서 조립해 주세요. **CHI** 注意！检查部件方向和位置



ENG Cut crosspieces before removing the part from the board. **UKR** Обріжте перемички перед витяганням деталі. **DEU** Schneiden Sie die Stege ein, bevor Sie das Teil rausnehmen. **FRA** Découpez les fixations avant de retirer les pièces. **POL** Obetnij uszczelnienia przed wyjmowaniem elementu. **SPA** Corte los puentes antes de extraer la pieza. **ITA** Tagliare gli elementi di collegamento prima di estrarre i particolari. **TUR** Parçaları çıkarmadan önce bağlantı yerlerini kesiniz. **RUS** Обрежьте соединительные перемычки перед выниманием детали. **KOR** 부품을 떼어내기 전, 연결 부분을 잘라 주세요. **CHI** 在取下部件前切断连接点

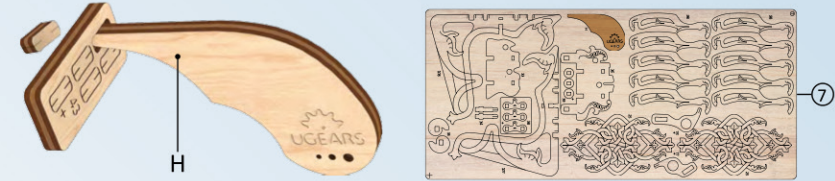

ENG This is not a structural component; it is a tool for measurement and assembly. **UKR** Це не деталь конструкції, а допоміжний інструмент для складання або вимірювання відстаней. **DEU** Es ist kein Teil der Konstruktion, sondern ein Hilfselement für den Zusammenbau oder für das Messen der Abstände. **FRA** Cette pièce ne fait pas partie de la construction mais constitue un outil annexe pour l'assemblage ou la mesure des distances. **POL** To nie detal konstrukcji, a pomocnicze narzędzie dla montażu i wymiaru odległości. **SPA** No es una pieza de la construcción sino un instrumento auxiliar para montar o para medir distancias. **ITA** Non è un componente del modello, ma un'attrezzatura aggiuntiva per il montaggio o il rilievo delle quote. **TUR** Yapı parçası değil. Kurulum yapmak veya mesafe ölçmek amacıyla kullanılan yardımcı alettir. **RUS** Это не деталь конструкции, а вспомогательный инструмент для сборки или измерения расстояний. **KOR** 이 부품은 조립을 위한 부품이 아니고 조립을 돕거나 측정을 위한 도구입니다. **CHI** 这不是装配零部件，是一种测量及安装辅助工具。



ENG The part should be easily rotated (moved). **UKR** Деталь повинна легко крутитися (рухатися). **DEU** Der Teil soll leicht gedreht (bewegt) werden. **FRA** La pièce doit tourner (se déplacer) aisément. **POL** Element powinien łatwo się kręcić (poruszać się). **SPA** La pieza debe ser fácil de girar (mover). **ITA** Il componente deve girare (muoversi) facilmente. **TUR** Parça kolayca dönmeli (hareket etmeli). **RUS** Деталь должна легко крутиться (двигаться). **KOR** 활하게 움직일 수 있어야합니다. **CHI** 此部件应灵活转动



ENG Auxiliary model "hammer". Use for rigid connections. **UKR** Допоміжна модель "Молоток". Застосовувати для жорстких з'єднань. **DEU** Hilfsmittel Multitool "Zange". Für eine starre Verbindung verwenden. **FRA** Pièce-outil "marteau". À utiliser sur les joints. **POL** Model pomocniczy "mloteczek". Dla sztywnych połączeń. **SPA** . Modelo auxiliar "martillo". Aplicar para las conexiones rígidas. **ITA** Modello ausiliario "martello". Da utilizzare per connessioni rigide. **TUR** Yardımcı model "çekiç". Sert bağlantılar için kullanın. **RUS** Вспомогательная модель "Молоток". Использовать для жестких соединений. **KOR** 부가 모델 "해머". 견고한 결합을 위해 사용. **CHI** 辅助性模型"木槌"使用刚性连接

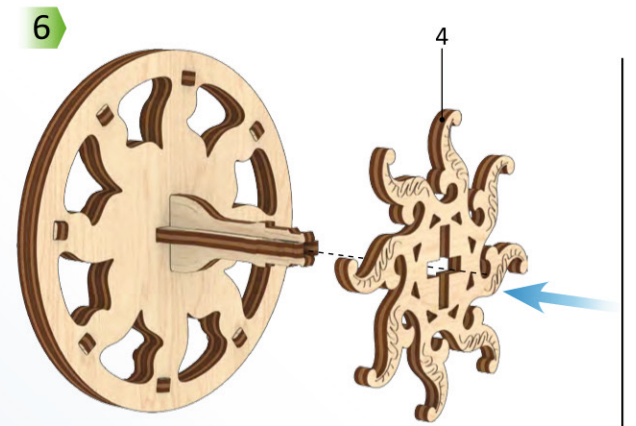
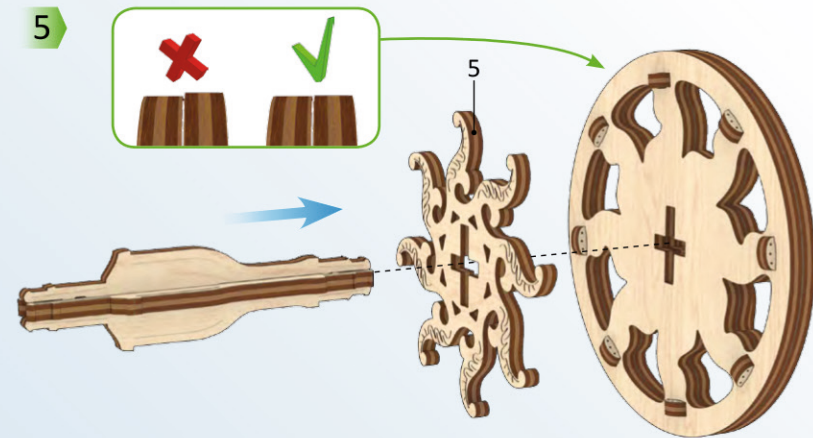
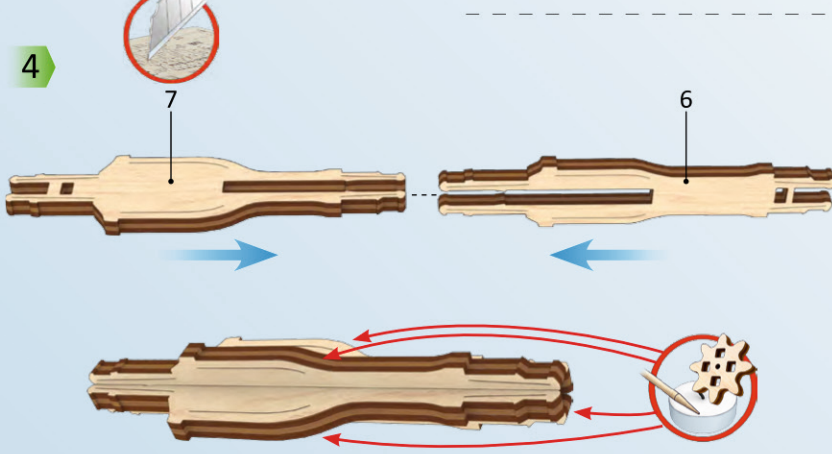
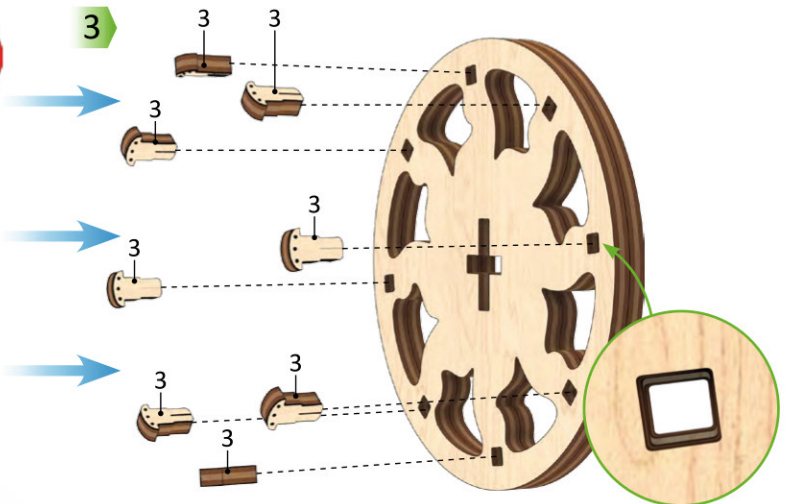
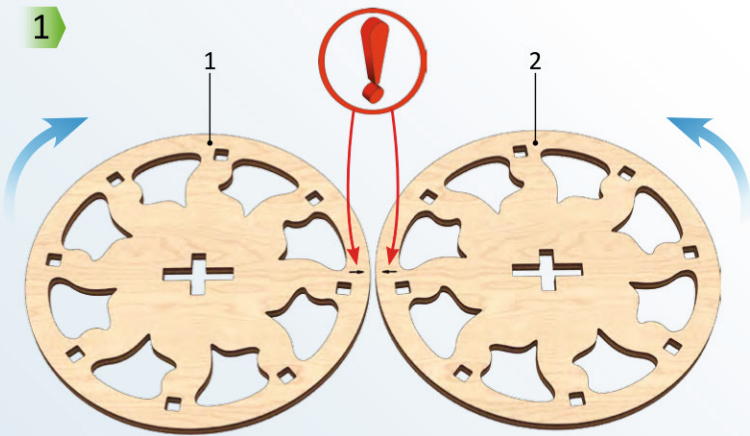
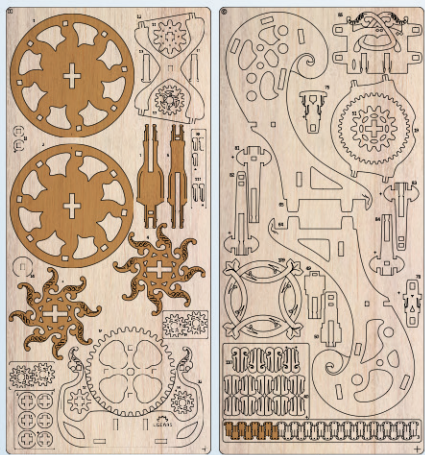

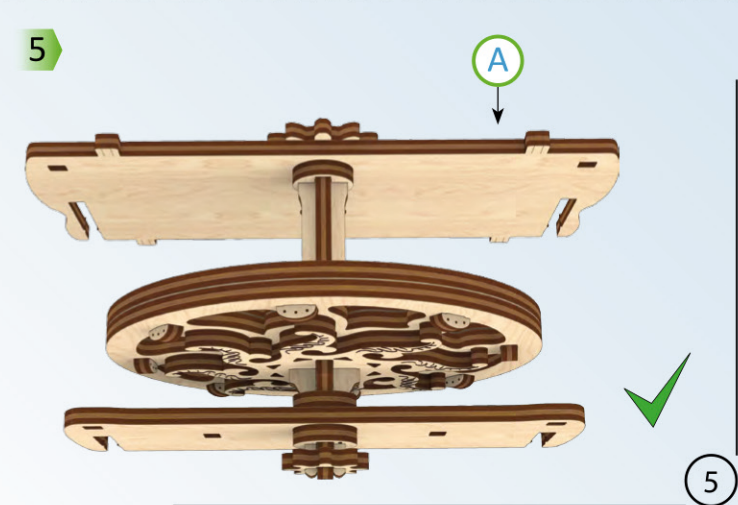
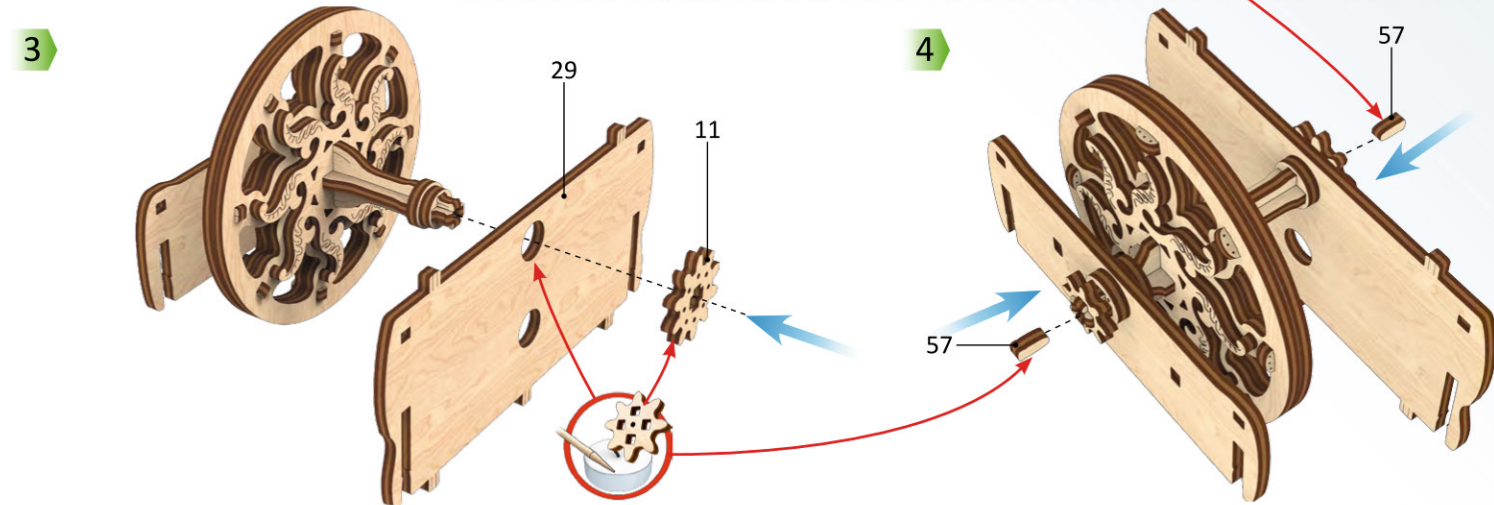
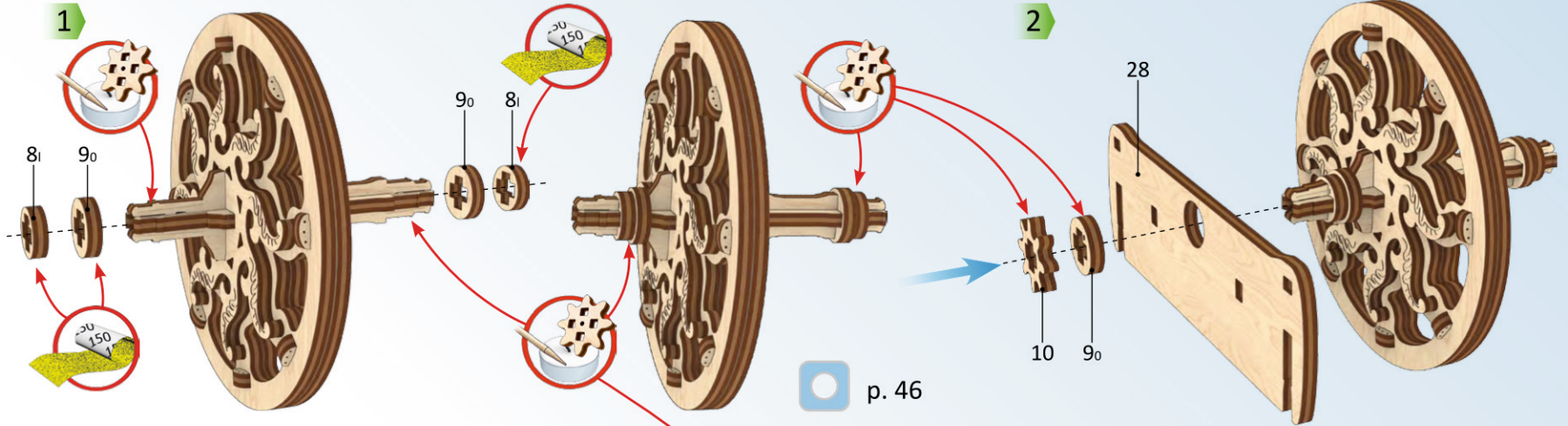

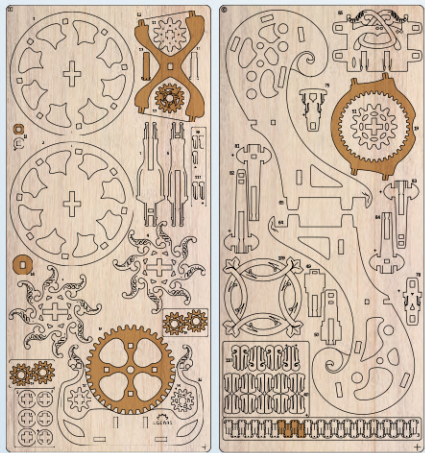

1

6

4

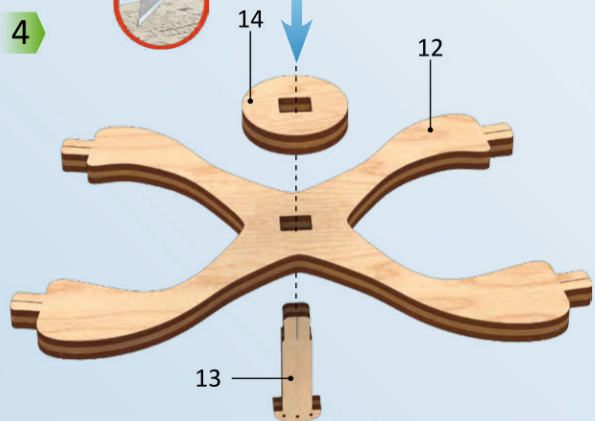

13

6

1

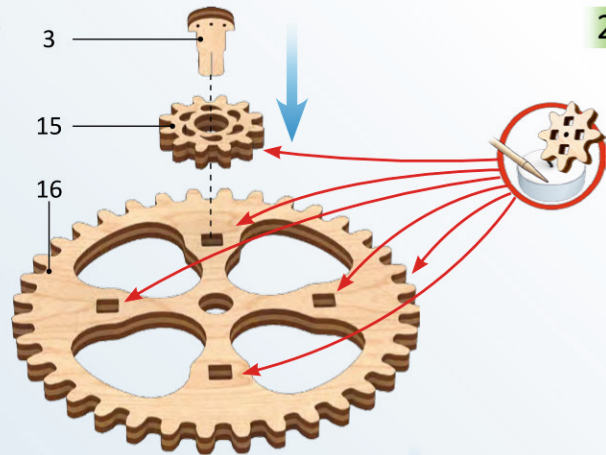

3

15

16

2

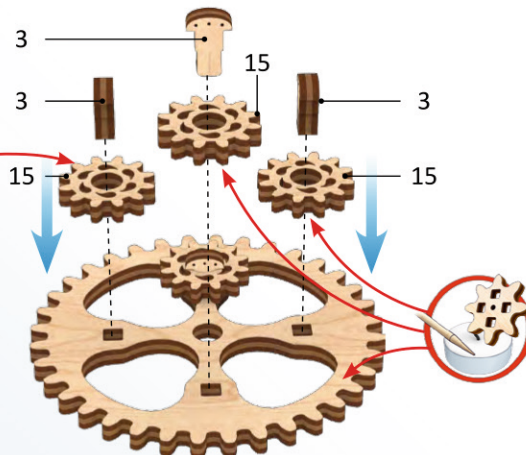

3

3

15

3

15

3



5

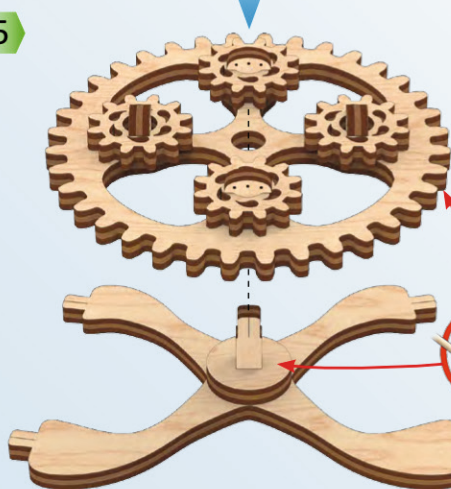

6

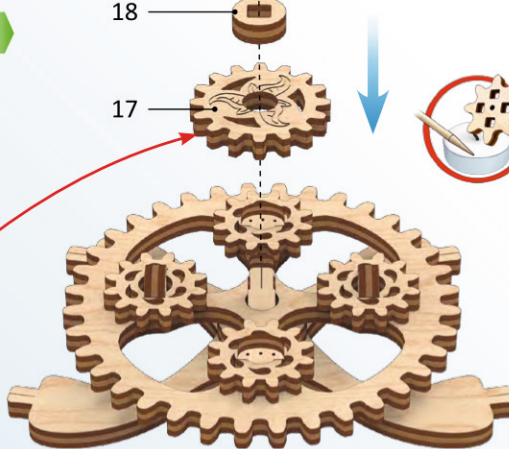

18

17

7

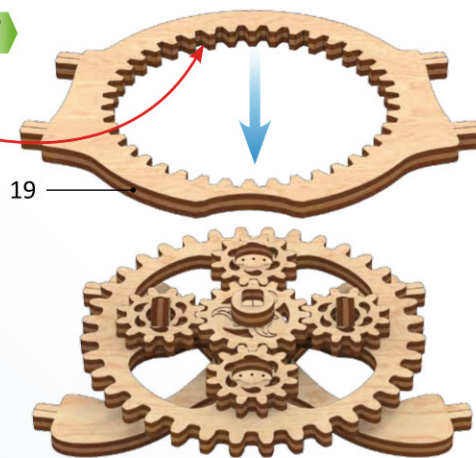

19

6

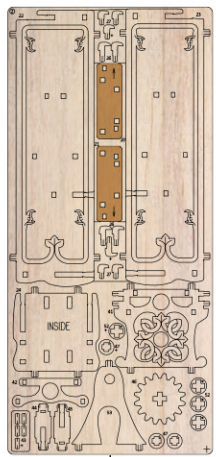

1



2

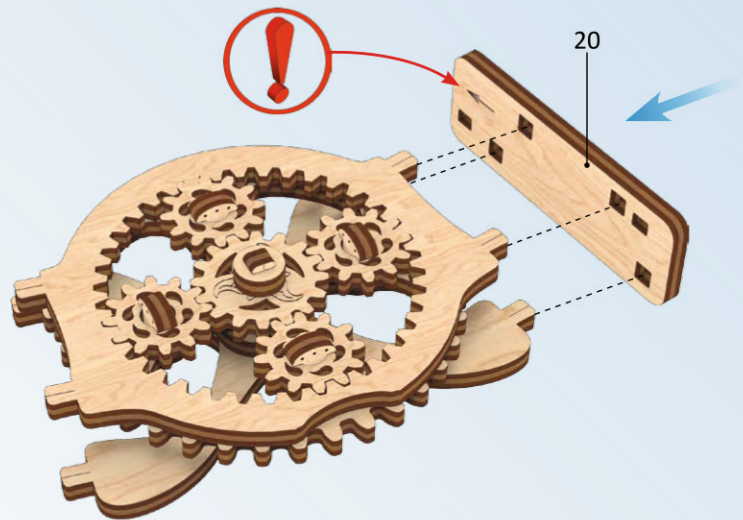

3

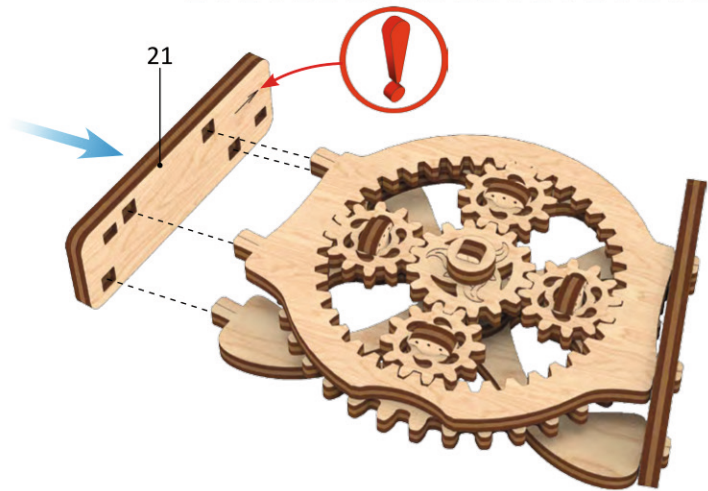

4

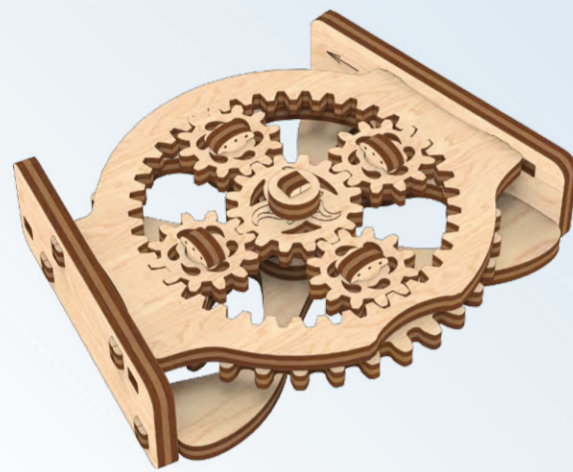

B



7

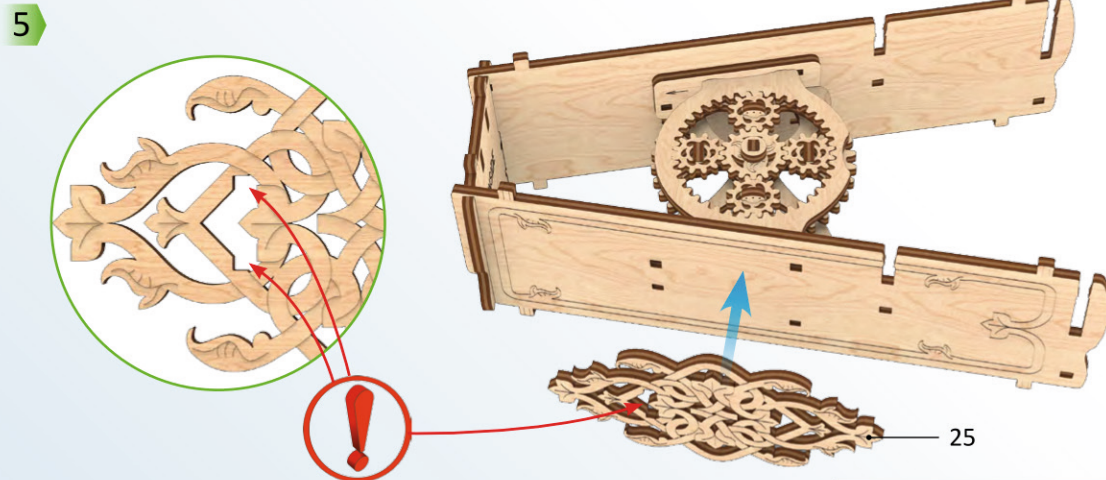
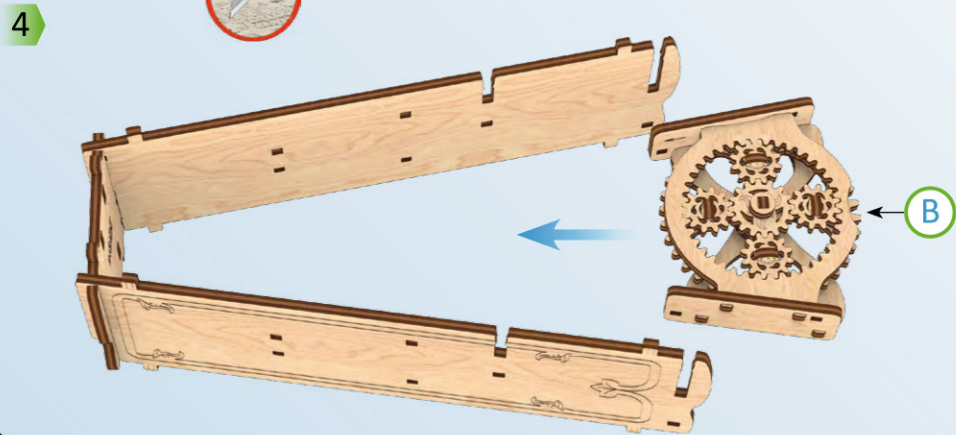
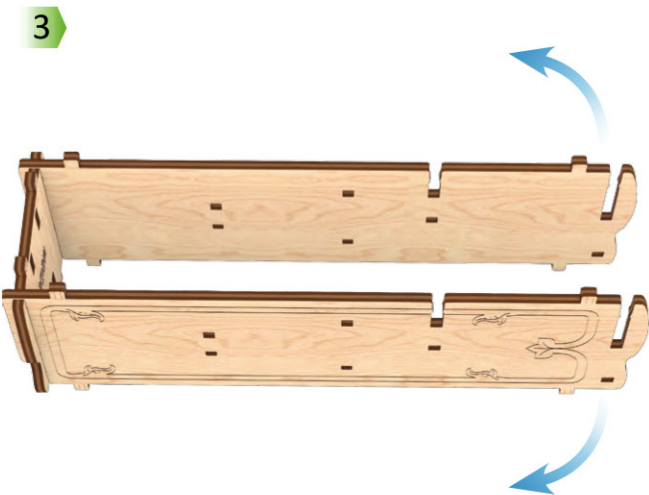
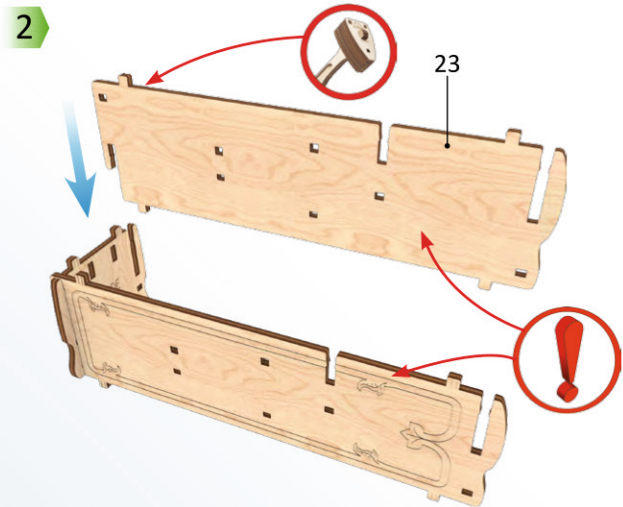
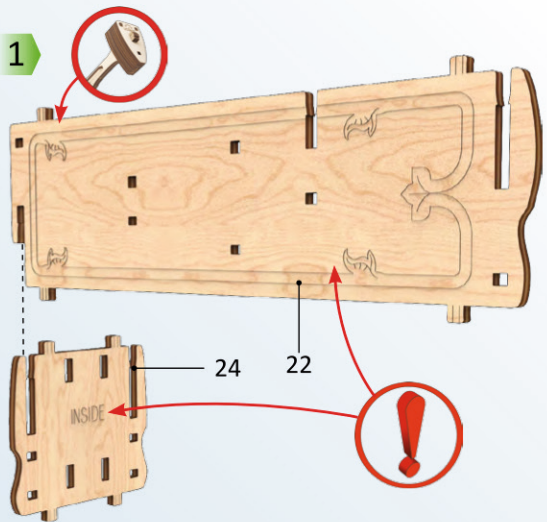
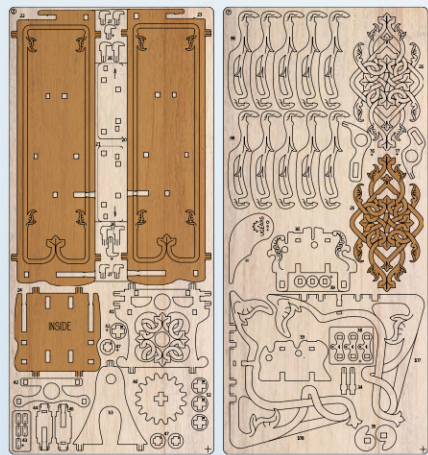

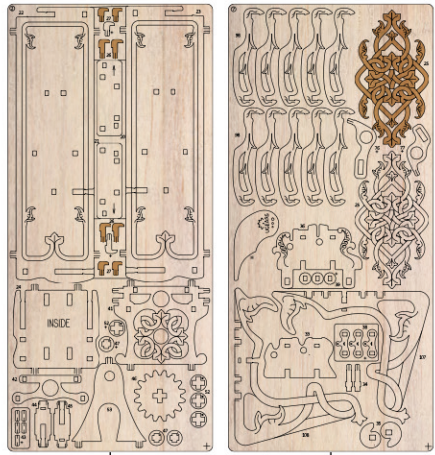

1

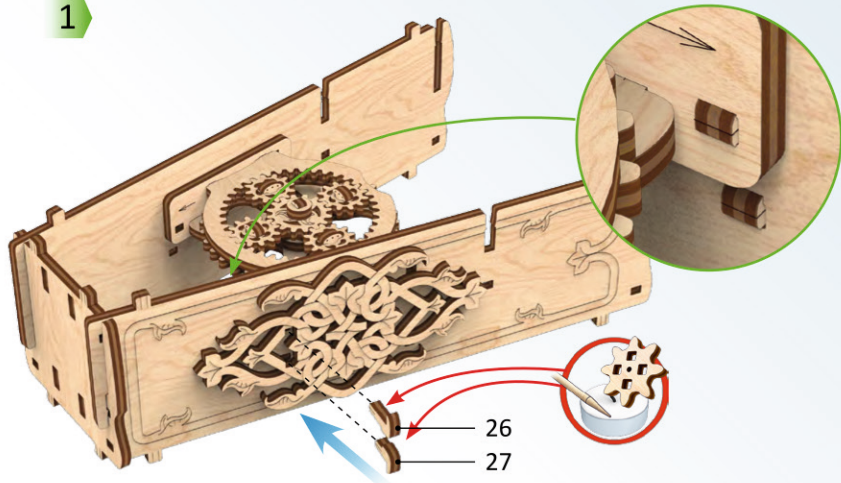

2

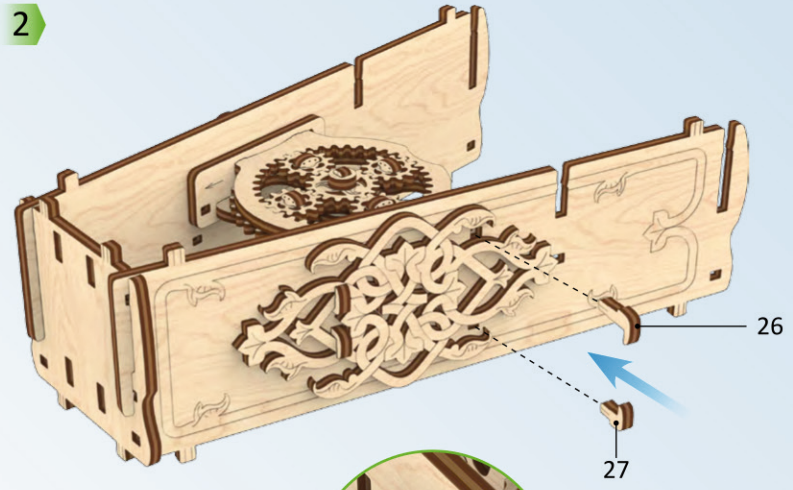

3

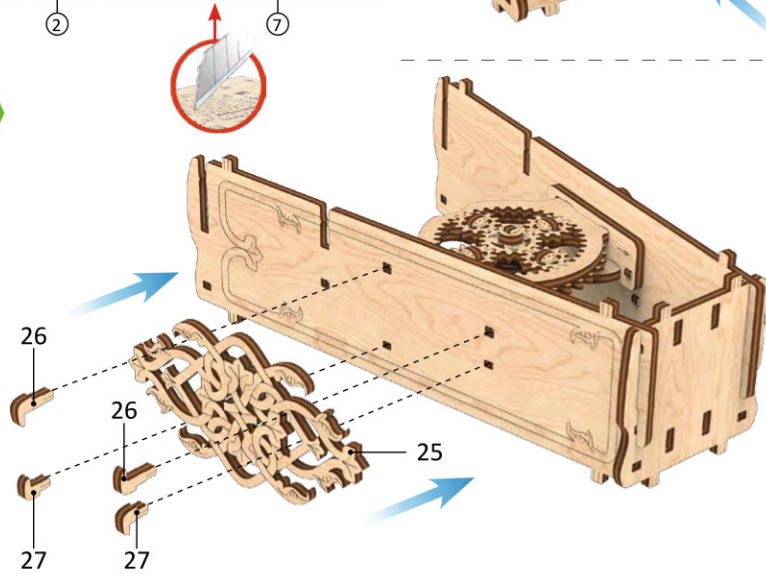

4

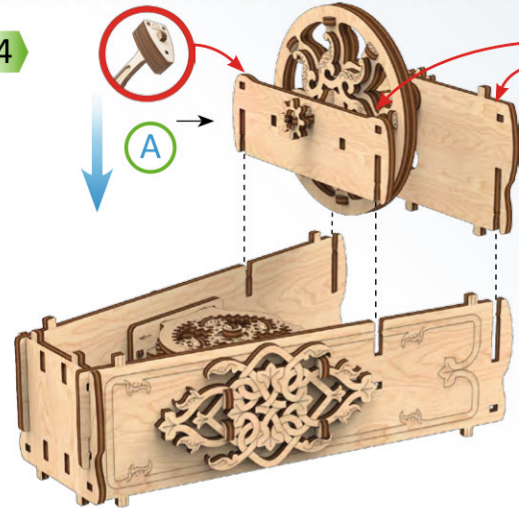

5

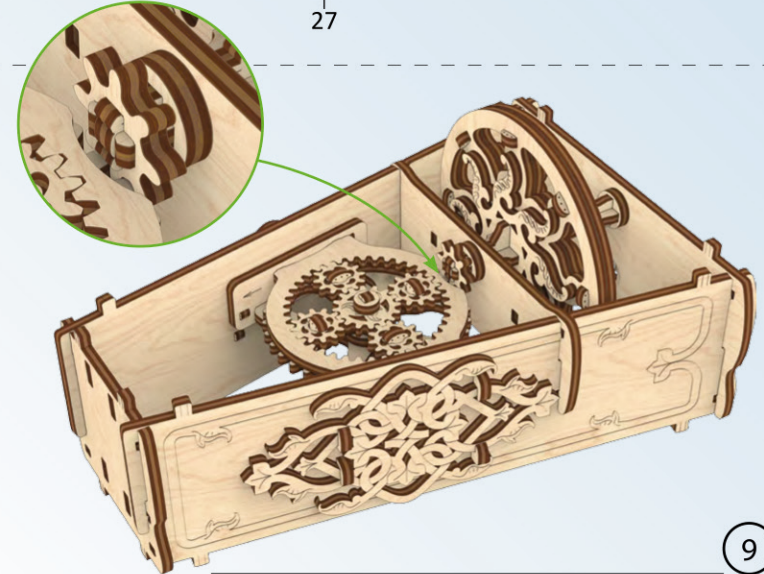

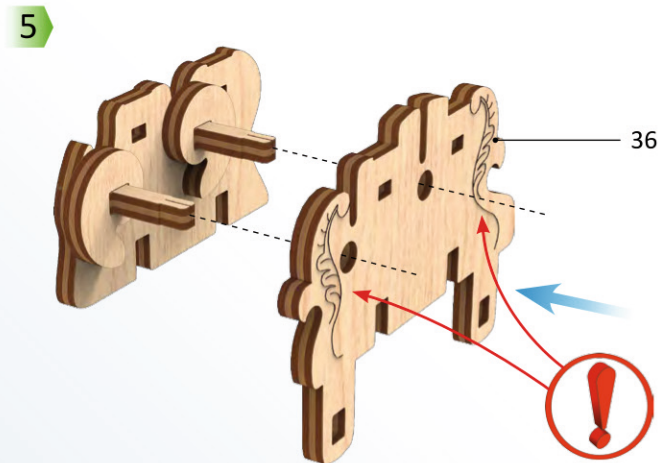
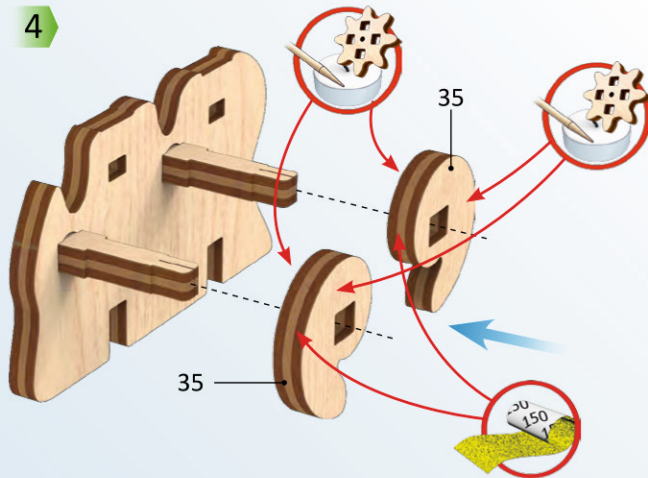
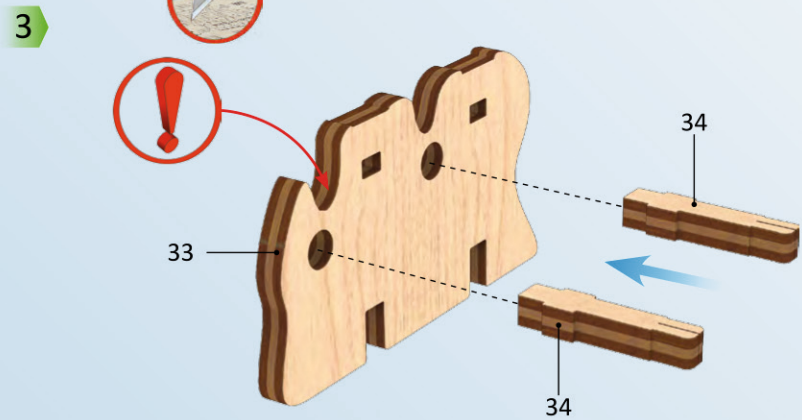
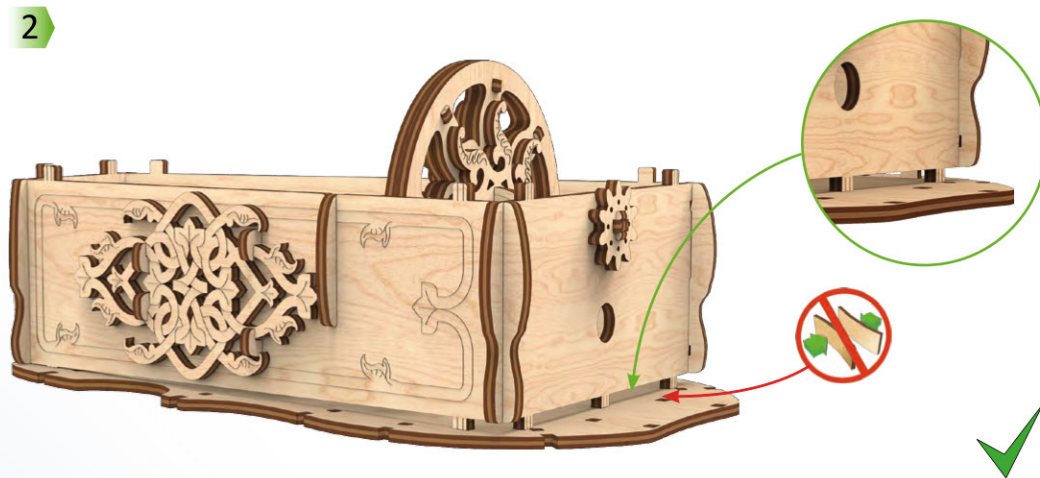
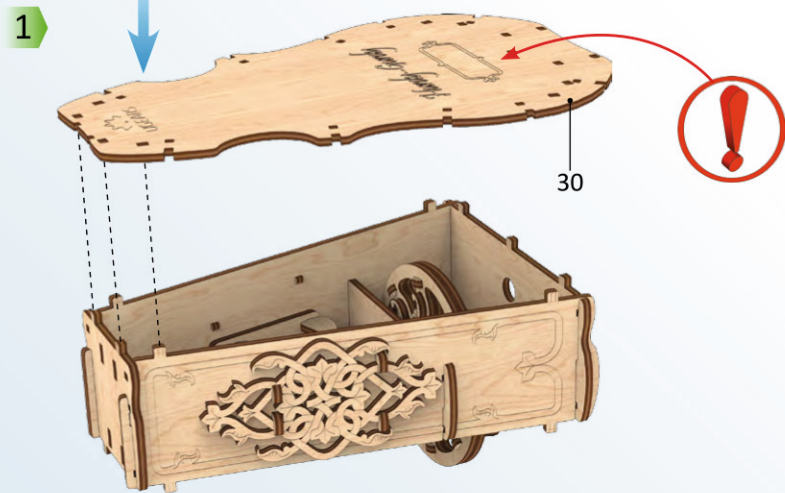
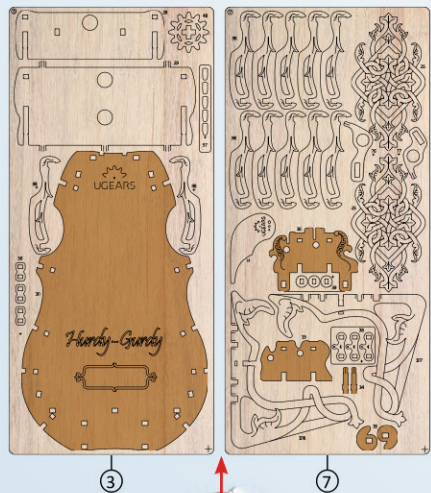

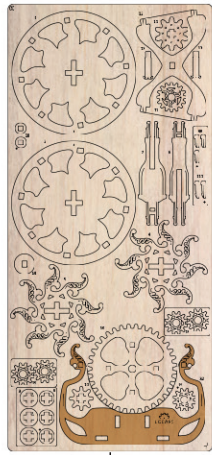

1



4

1

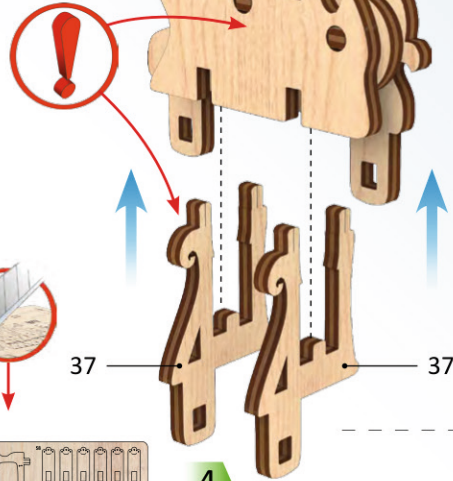

37

37

2

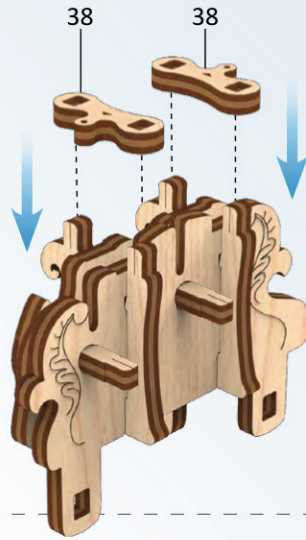

38

38

3

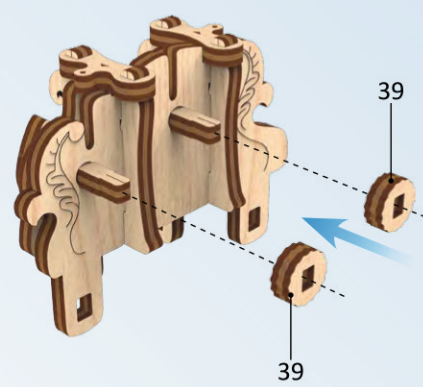

39

39

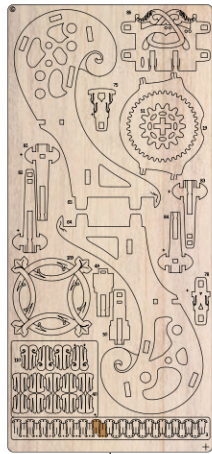

6

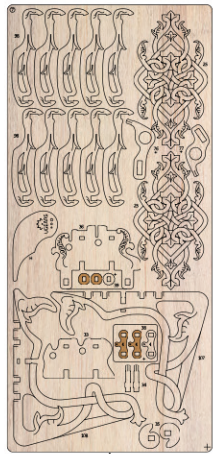

7

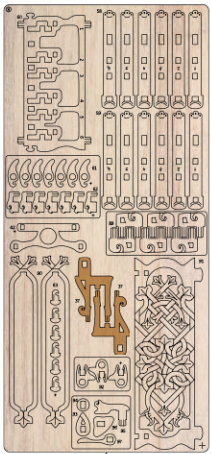

8

4

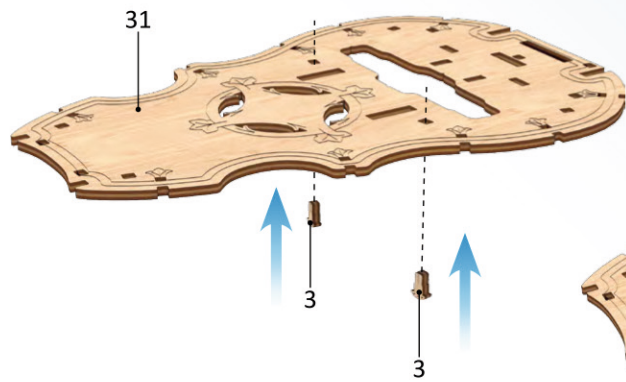

31

3

3

5

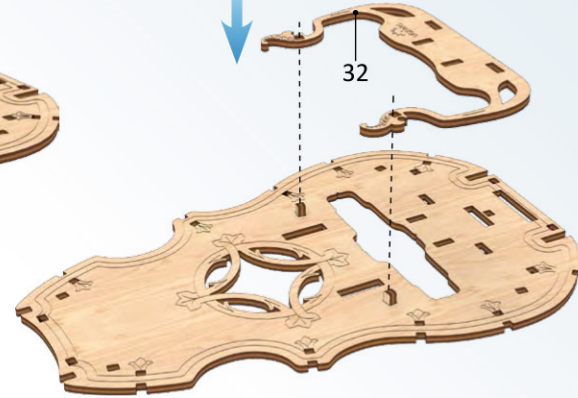

32



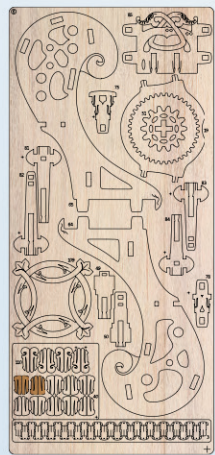

6

1

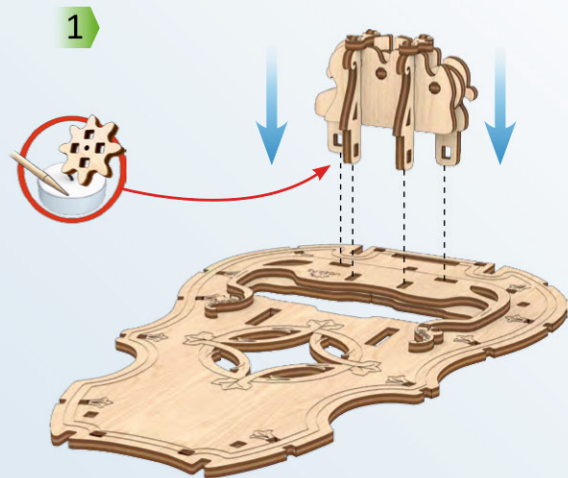

2

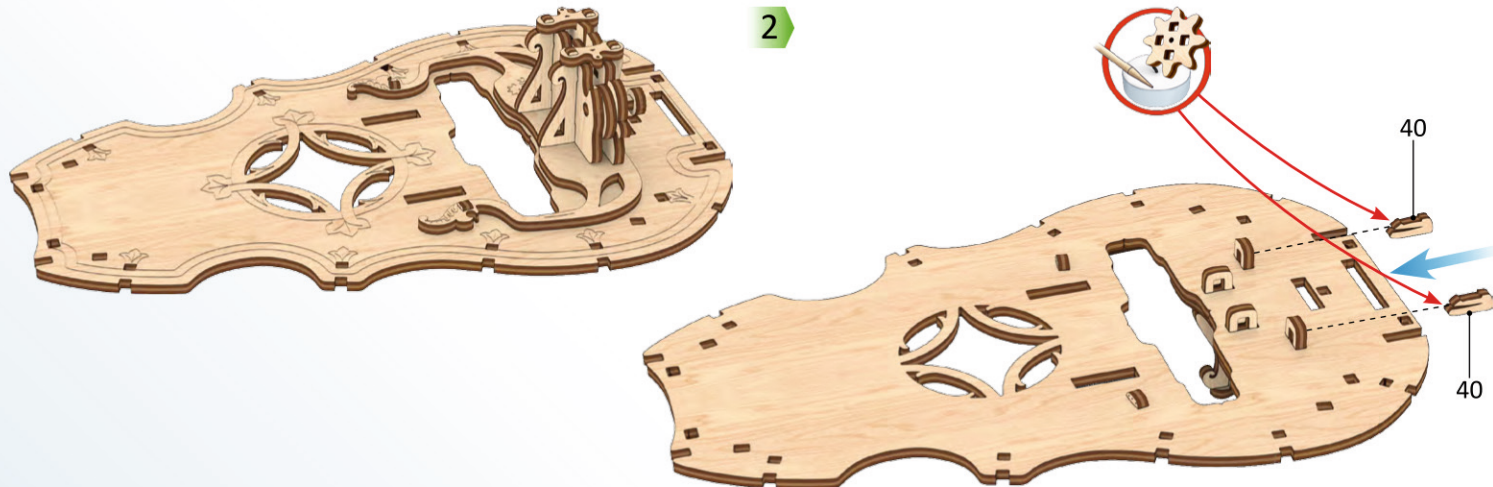

3

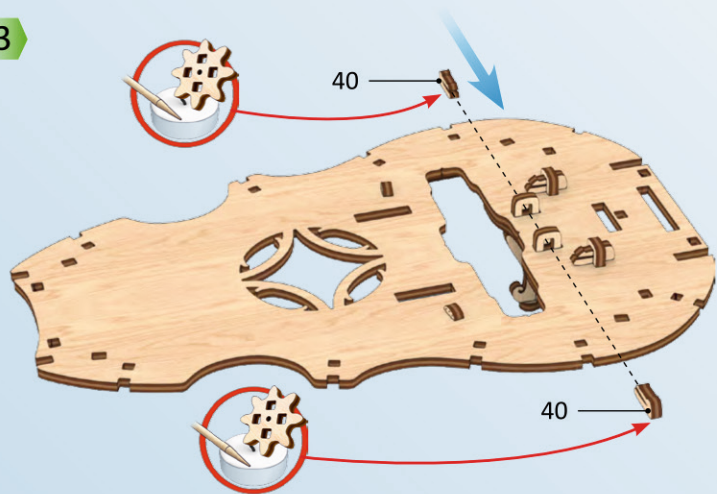

4

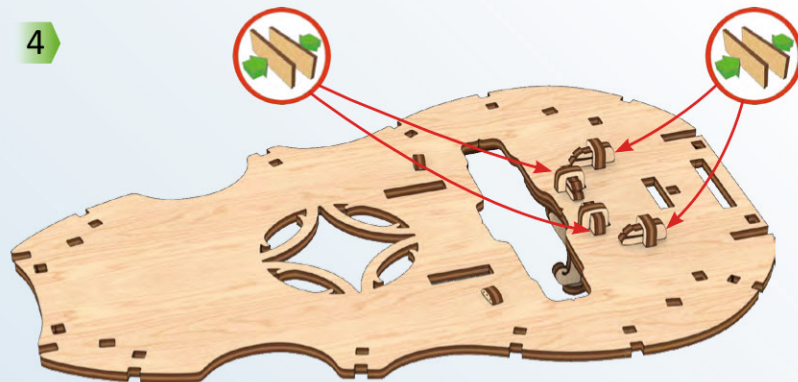

C



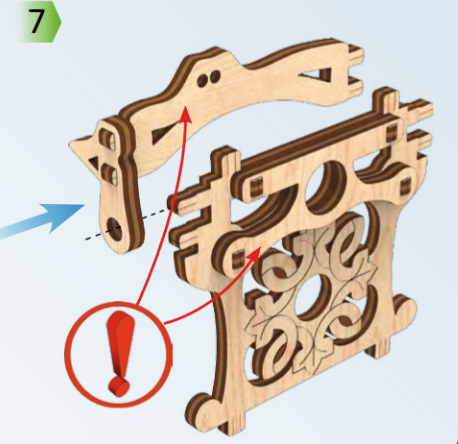
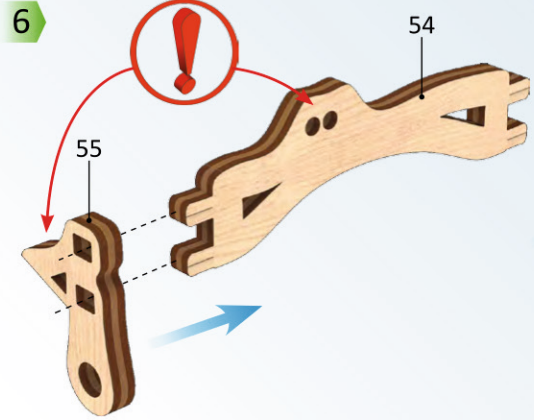
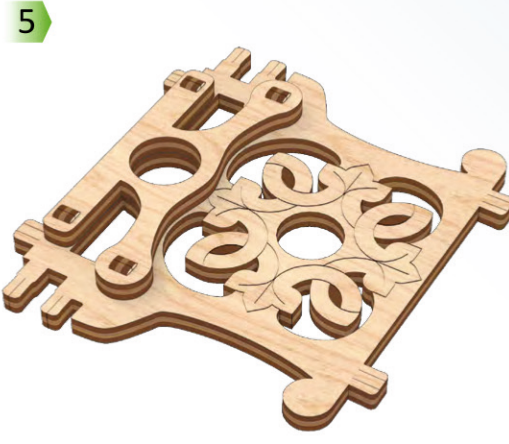
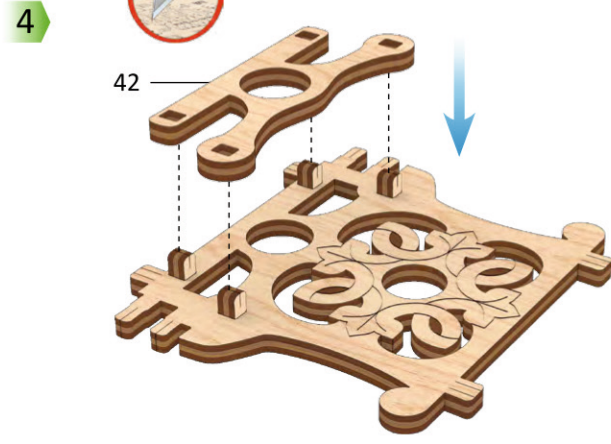
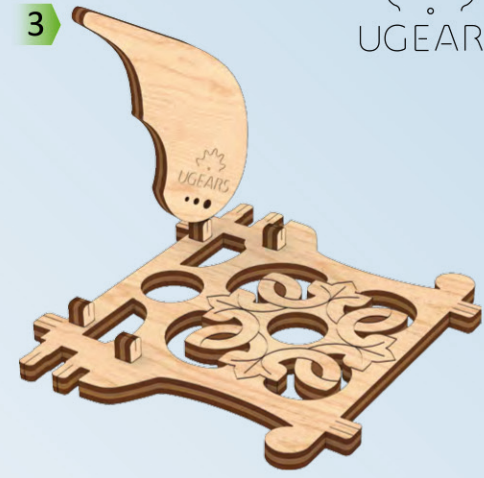
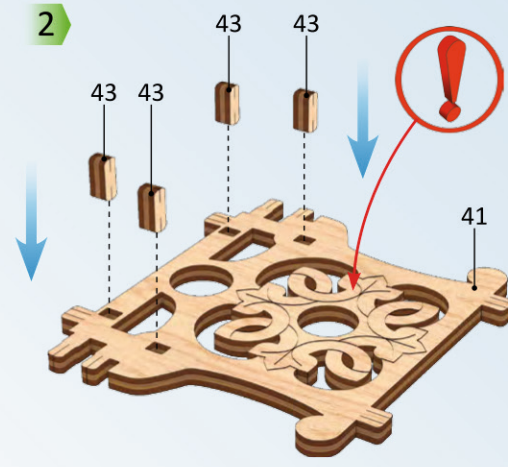
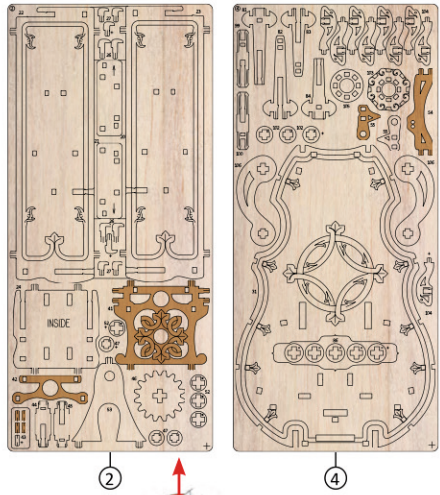

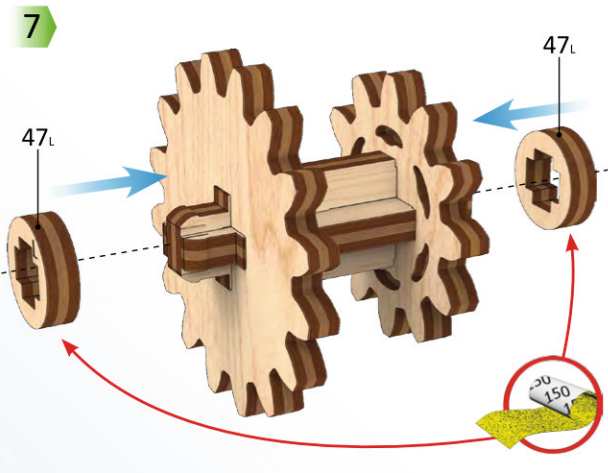
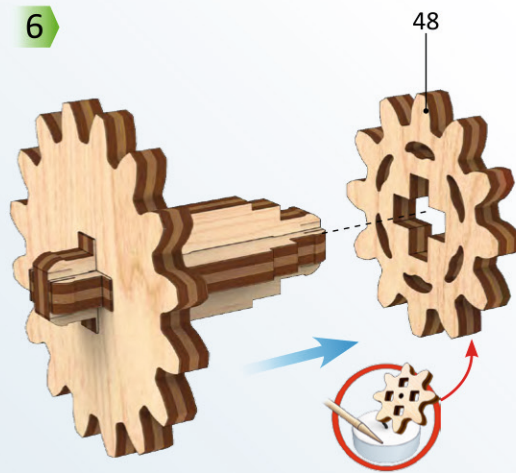
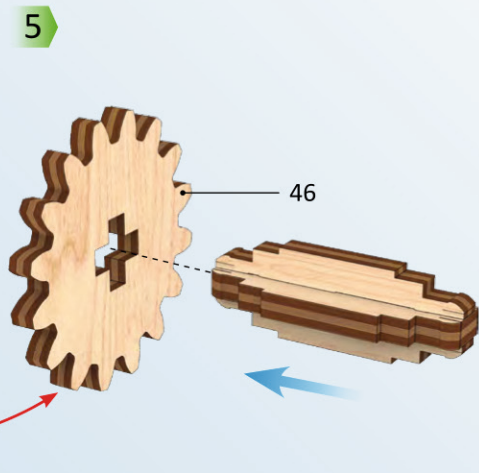
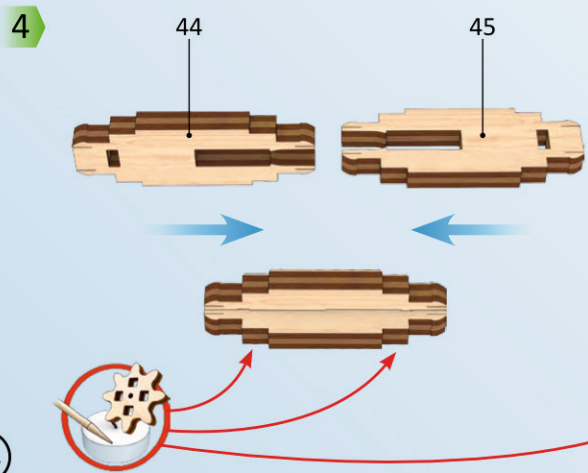
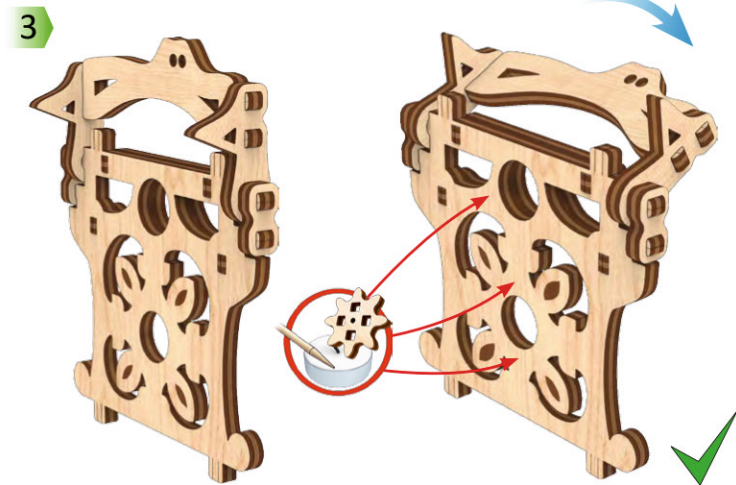
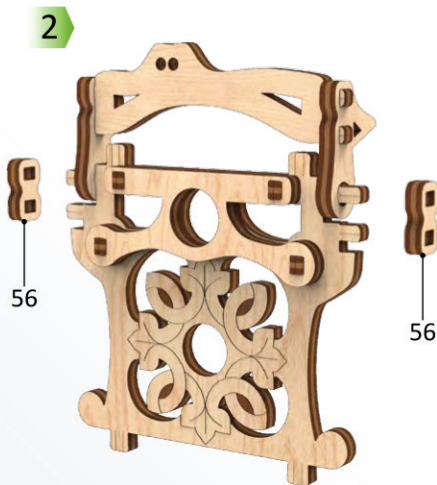
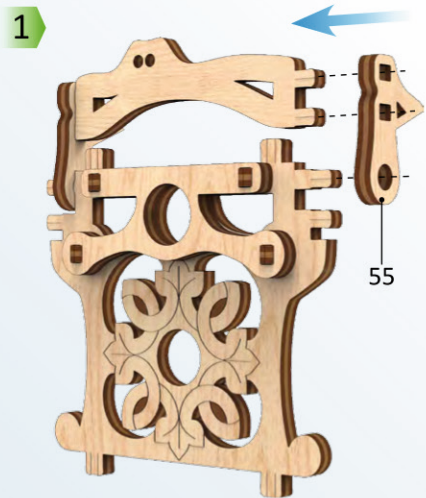
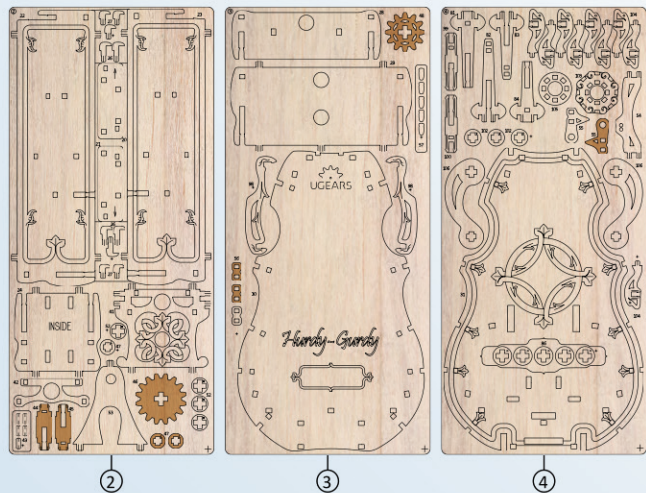

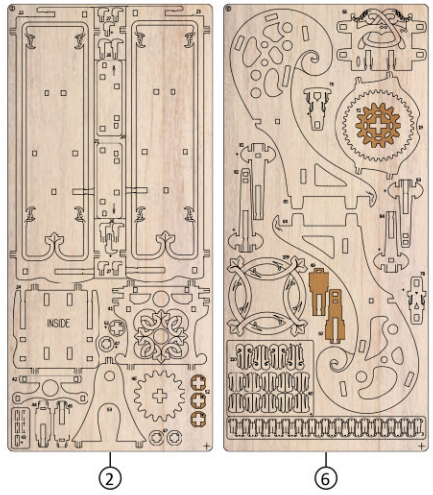

1

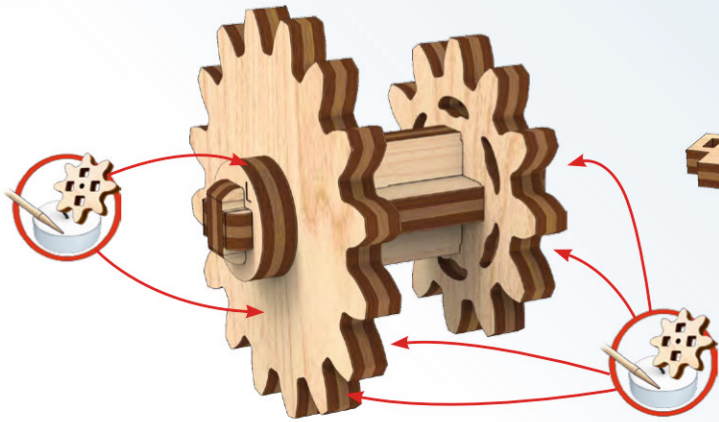

2

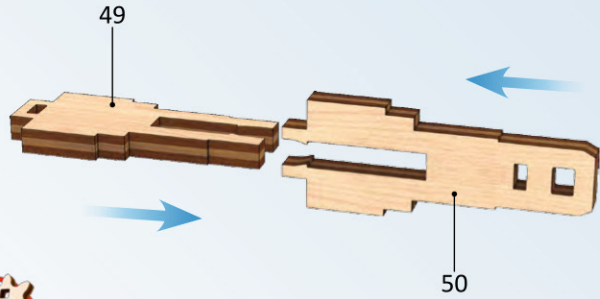

3

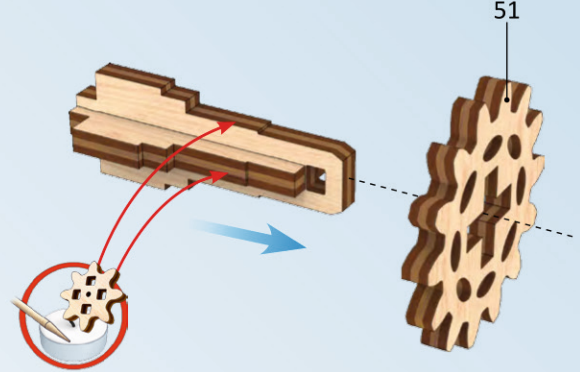

4

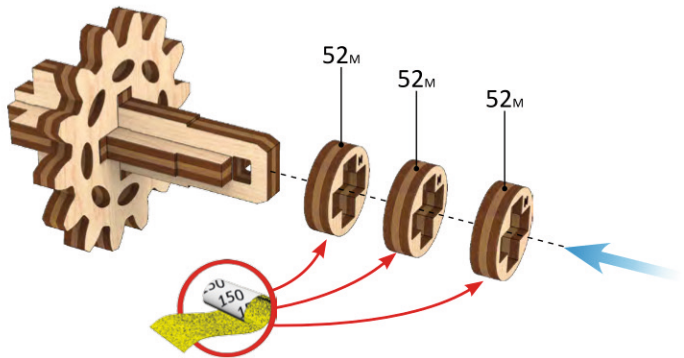

5

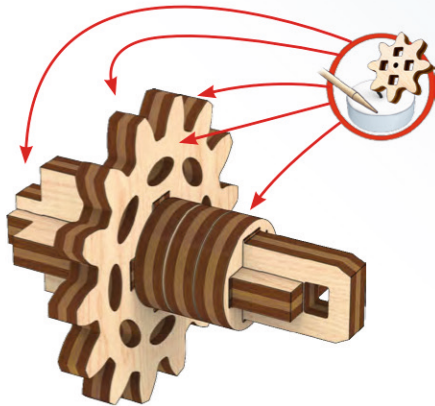

6

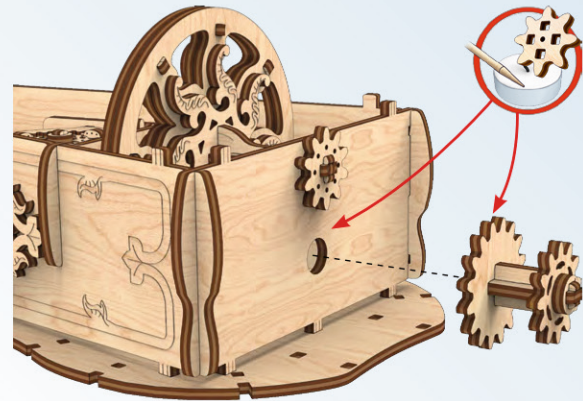

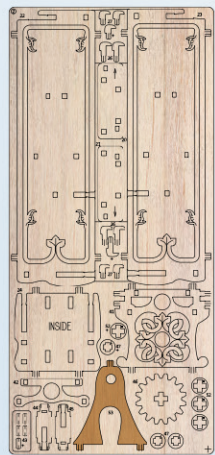

2

1

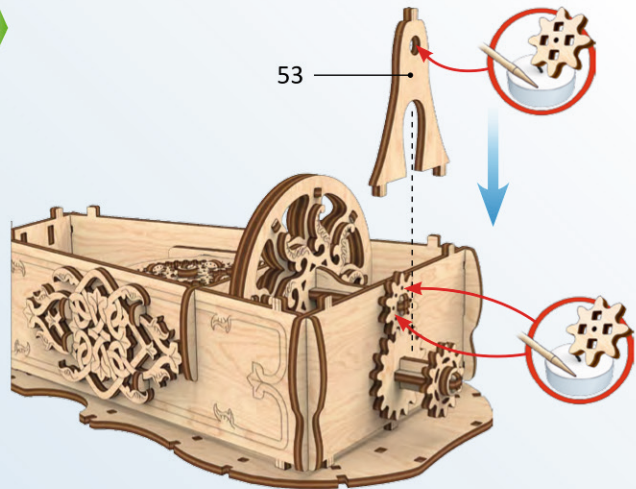

53

2

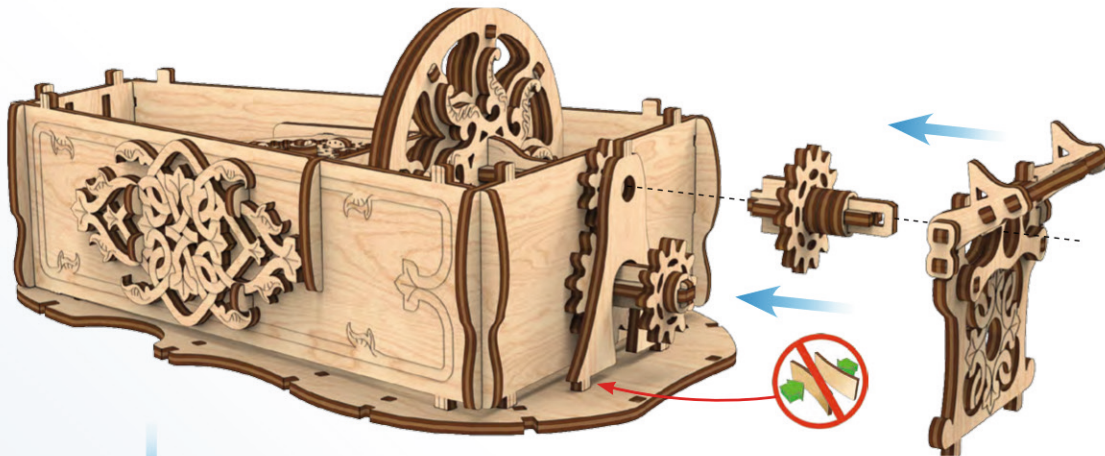

3

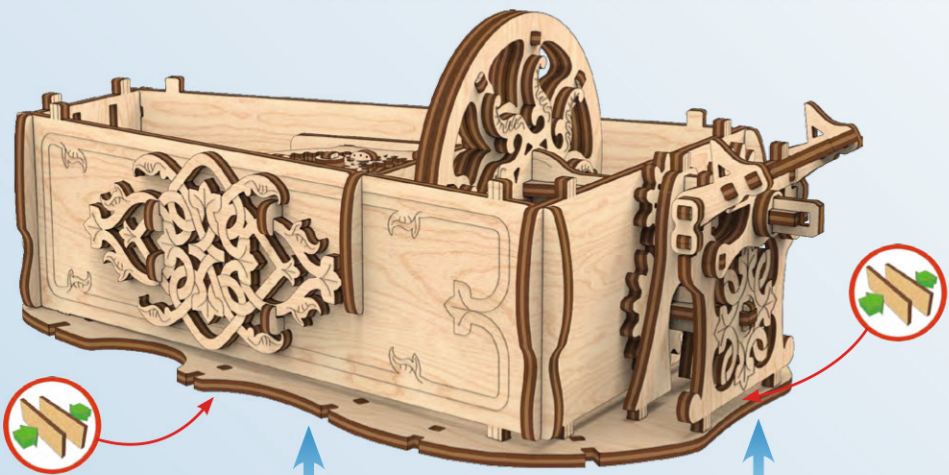

4

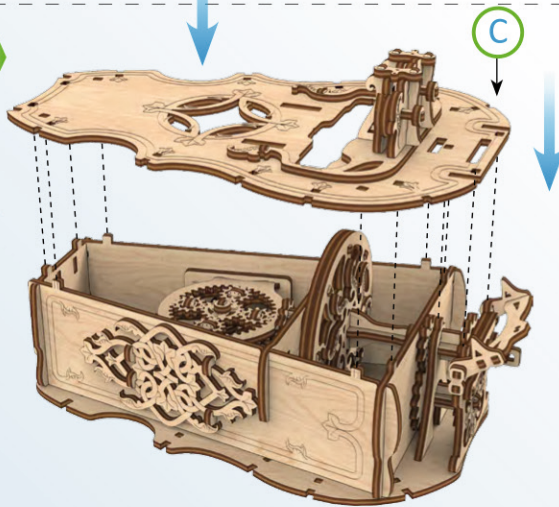

5

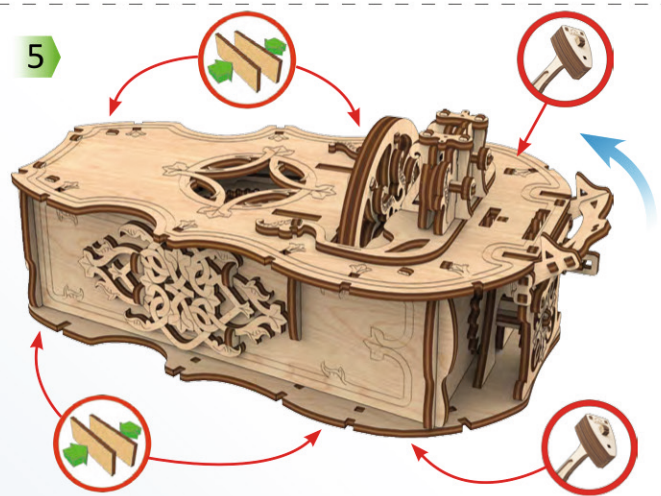

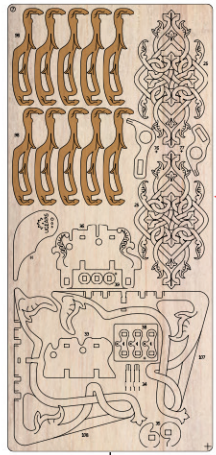

1

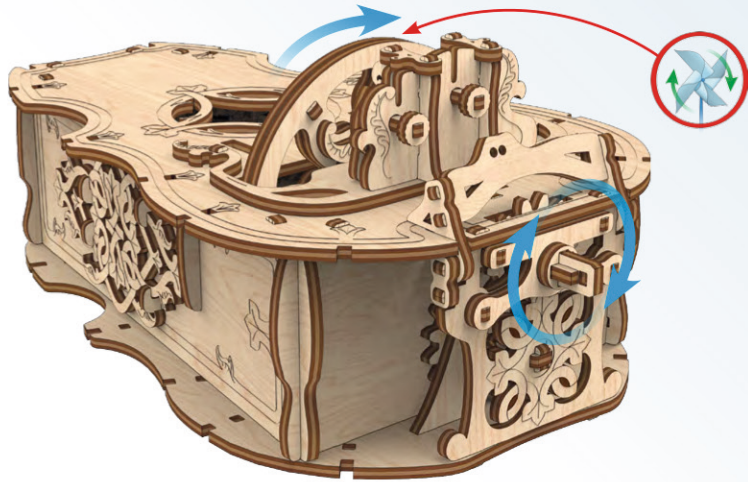

2



3

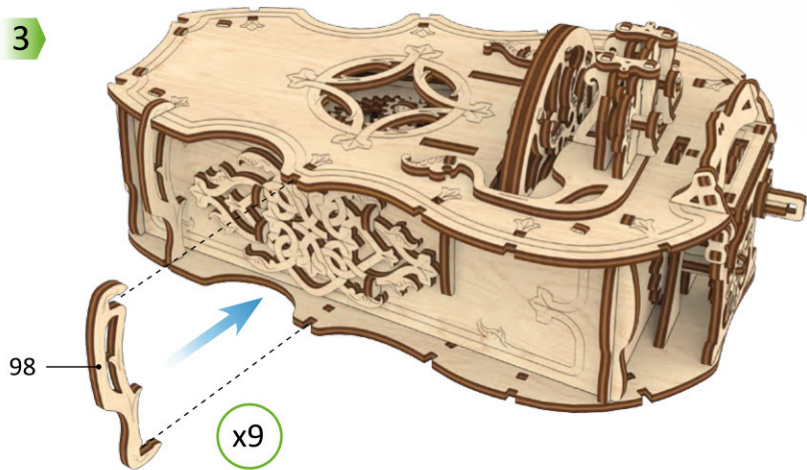

4

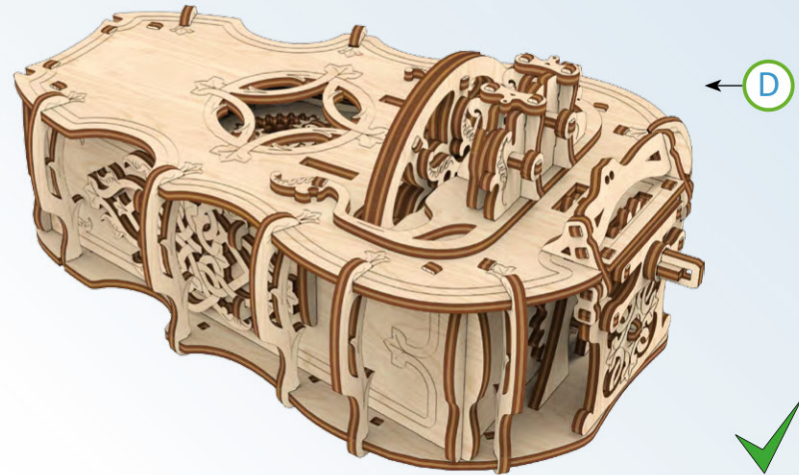

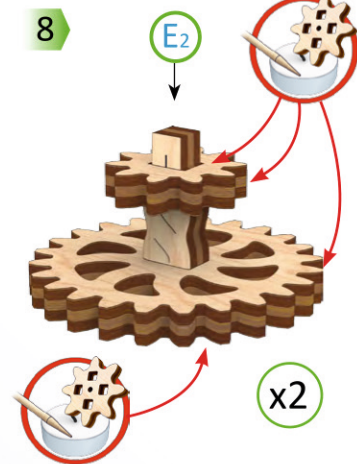
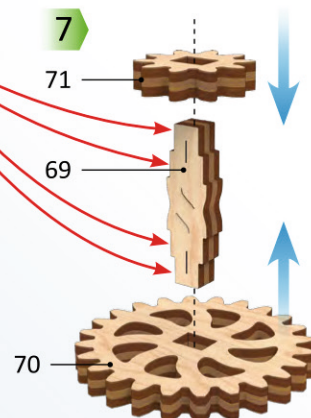
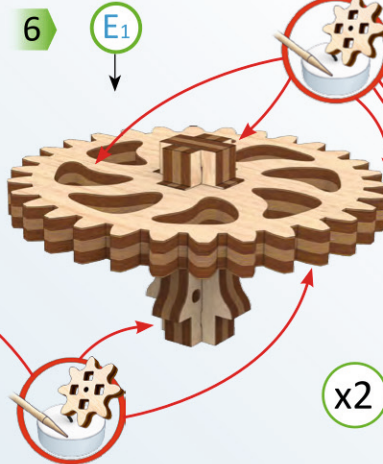
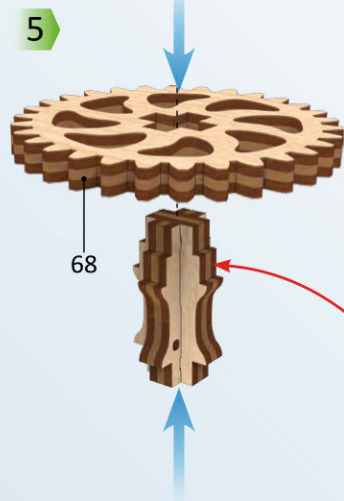
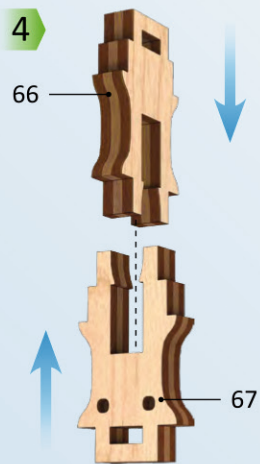
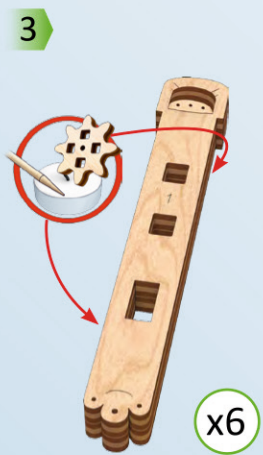
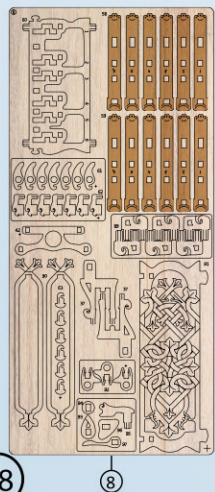
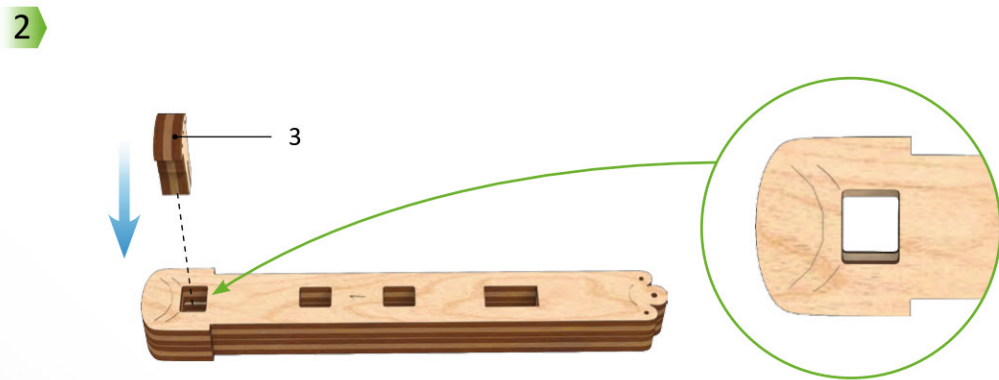
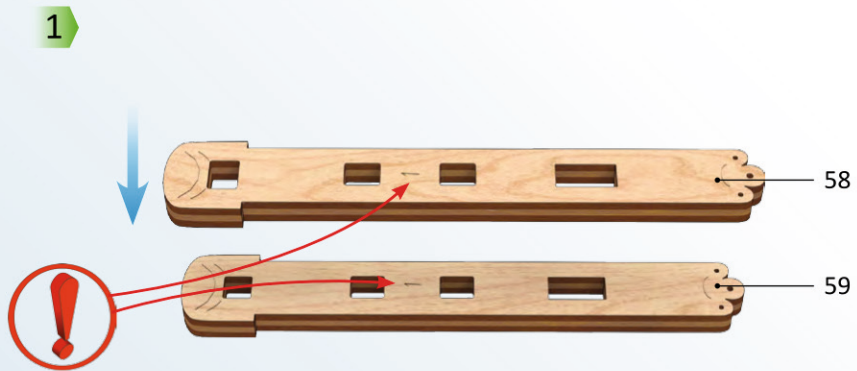
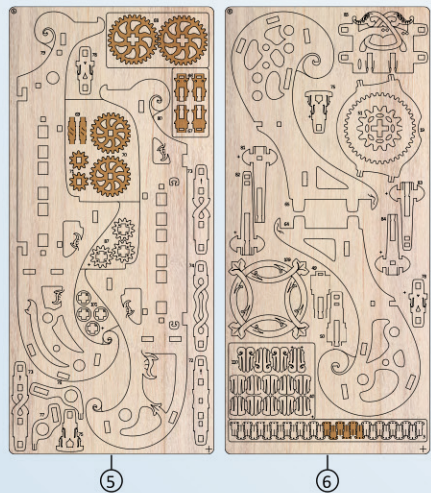

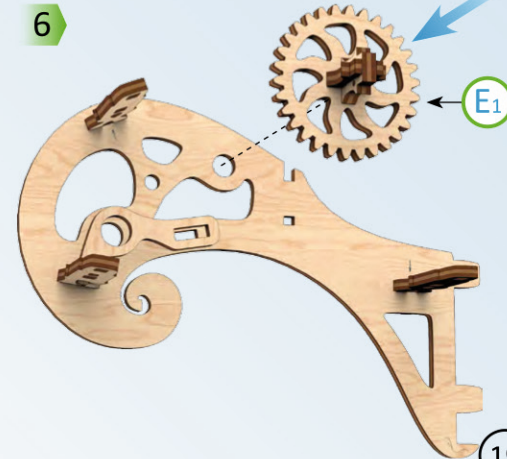
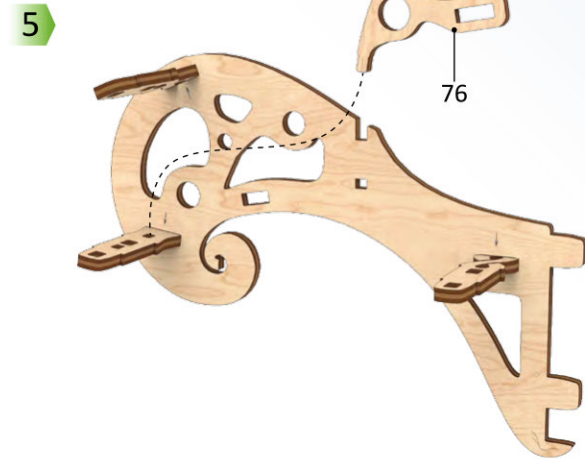
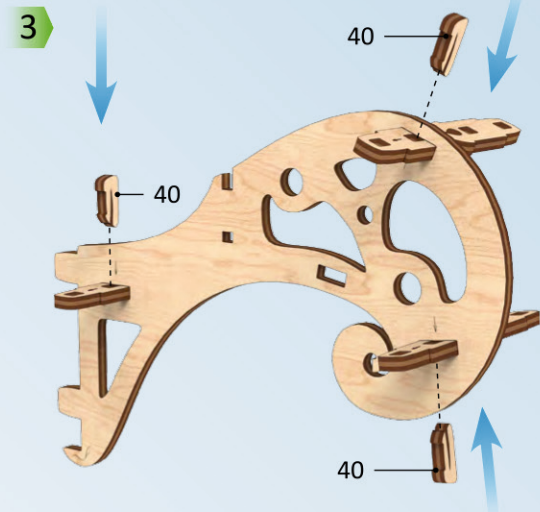
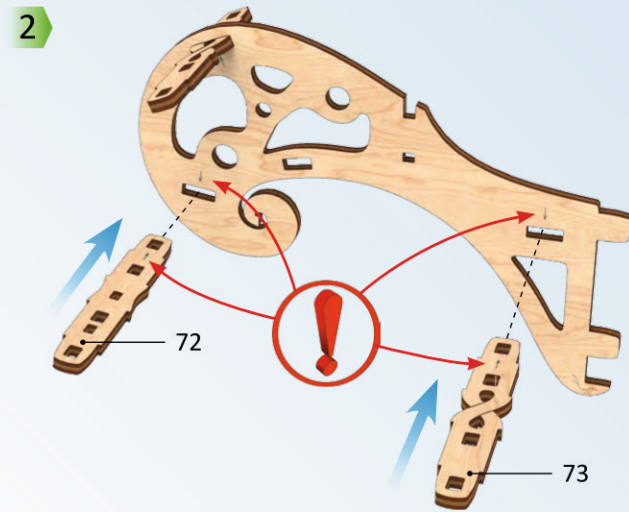
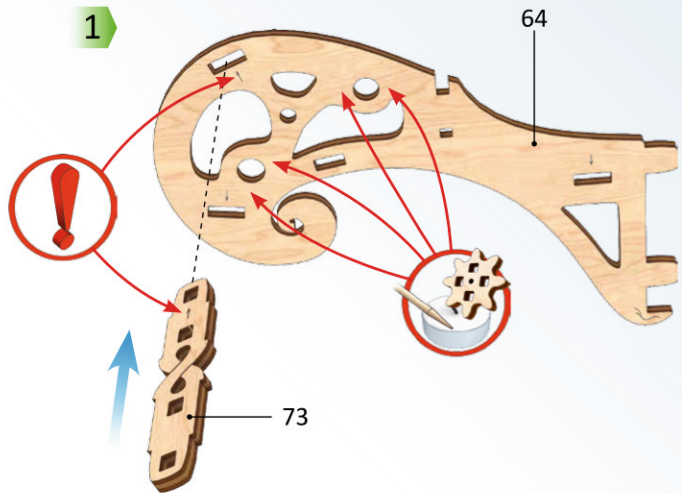
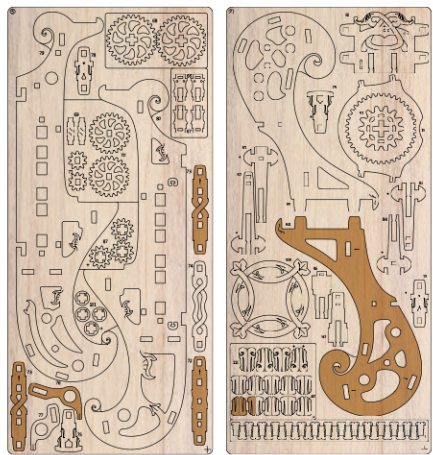

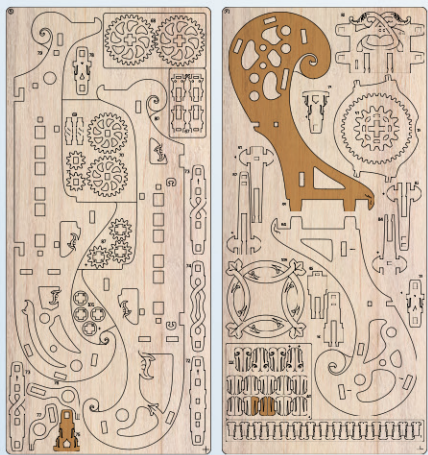

5

6

1

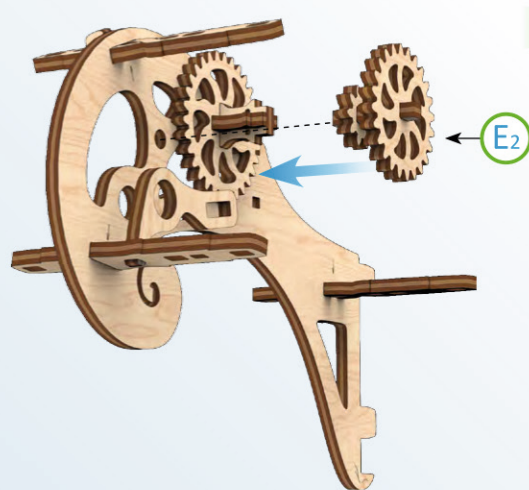

2

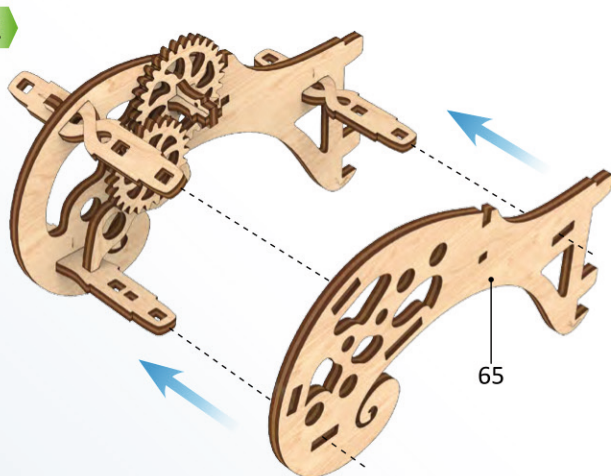

65

3

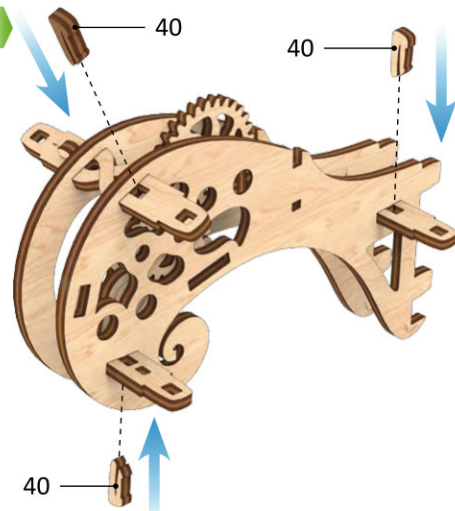

40

40

40

4



5

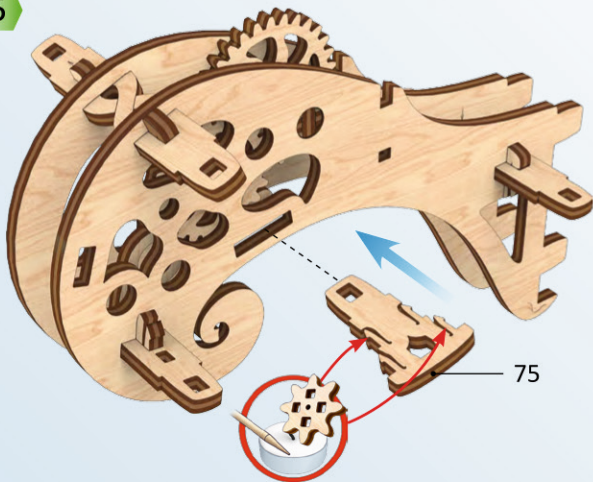

75

6

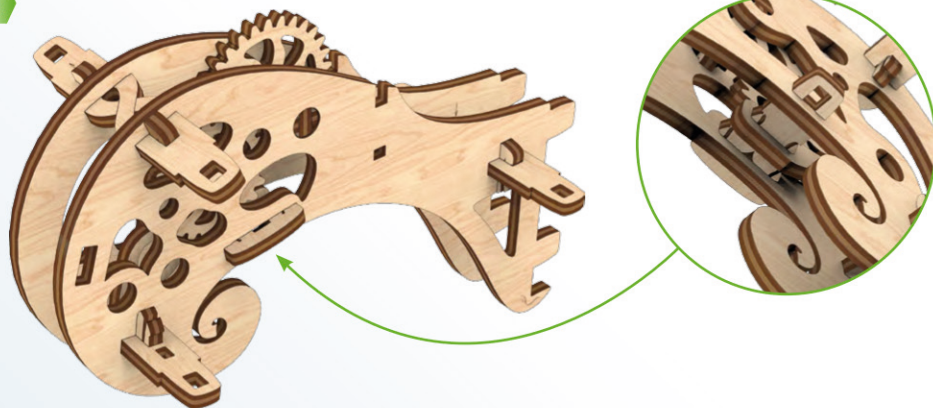

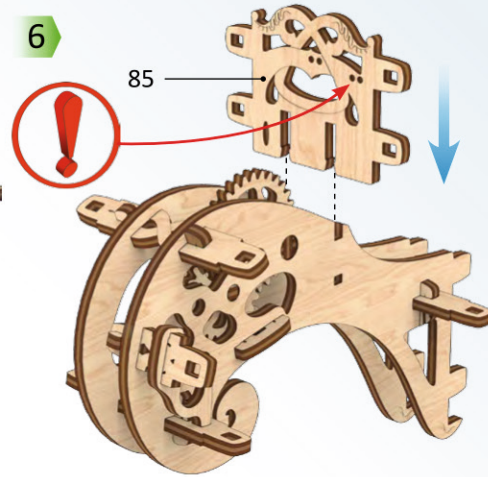
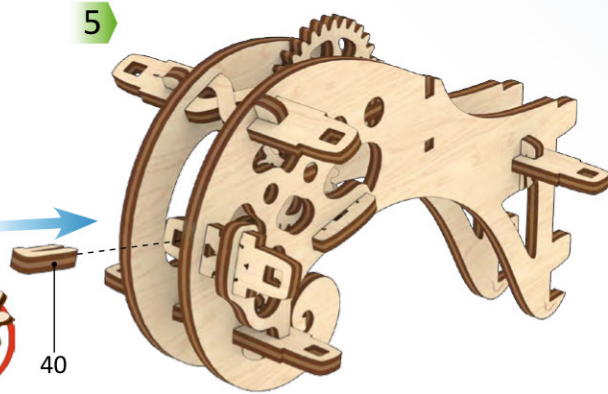
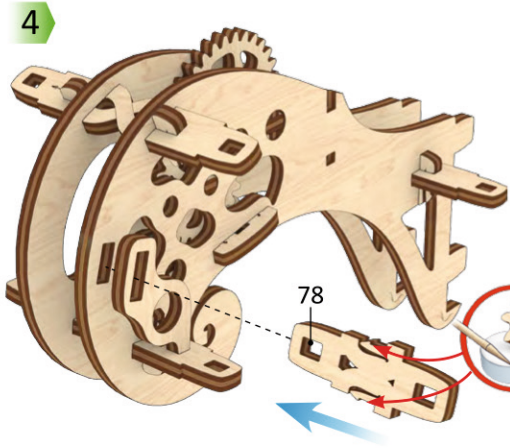
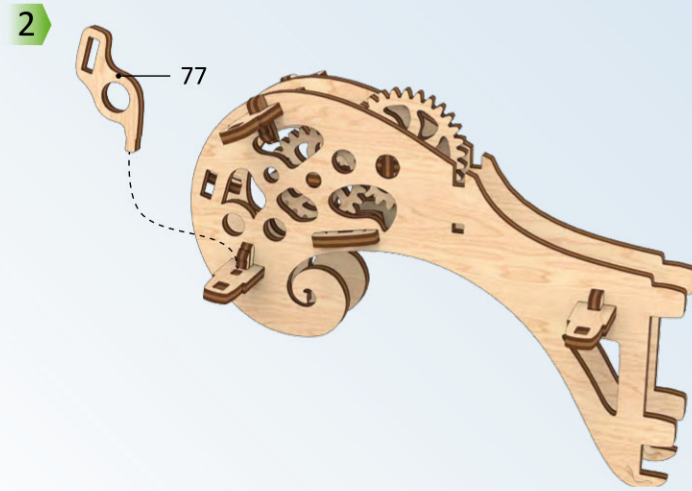
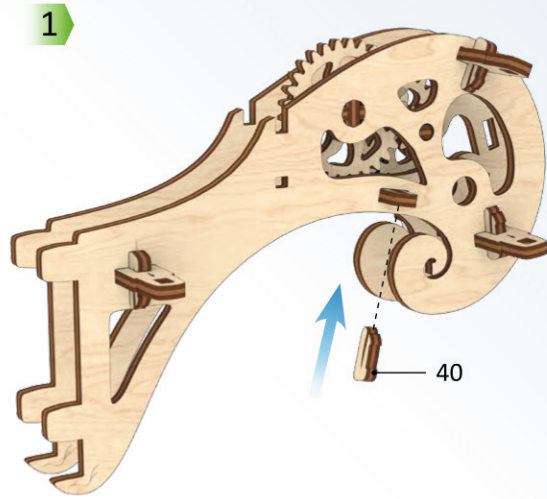
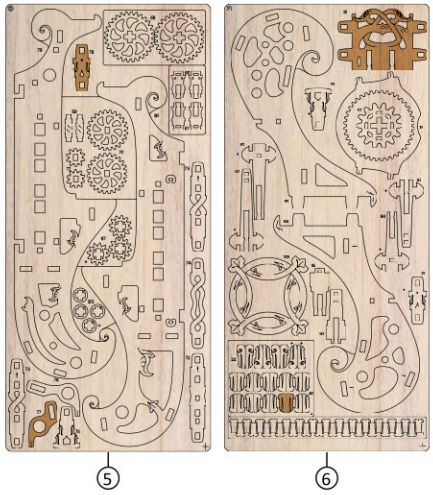

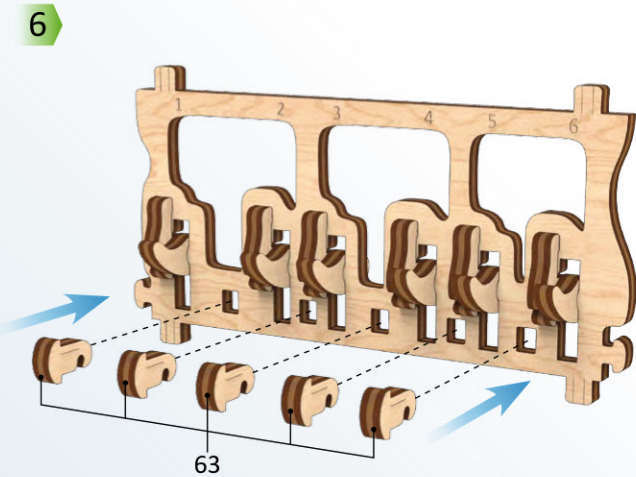
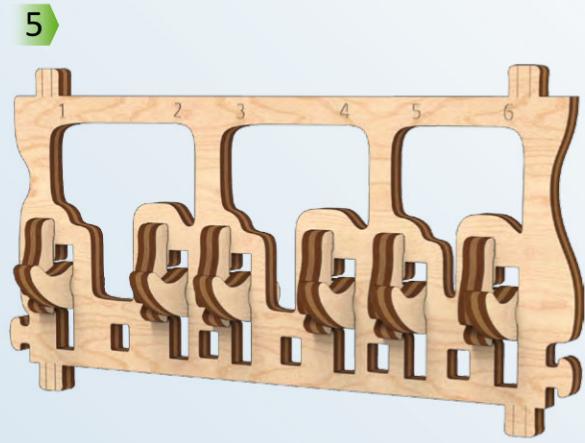
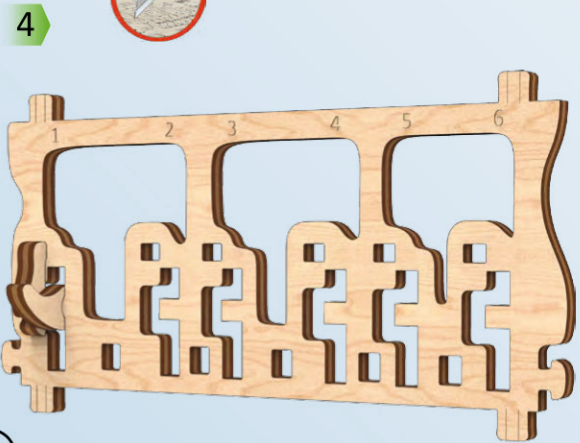
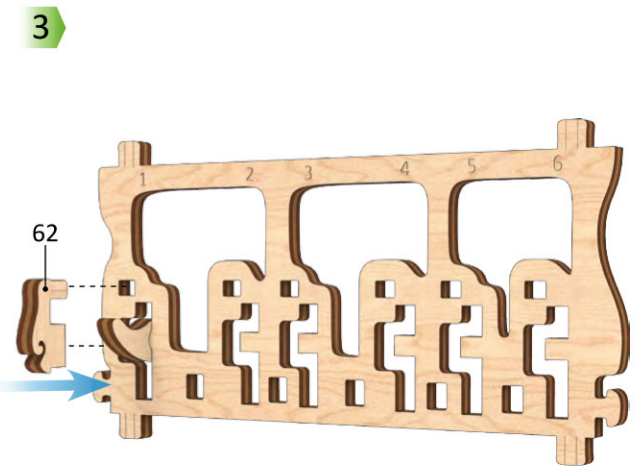
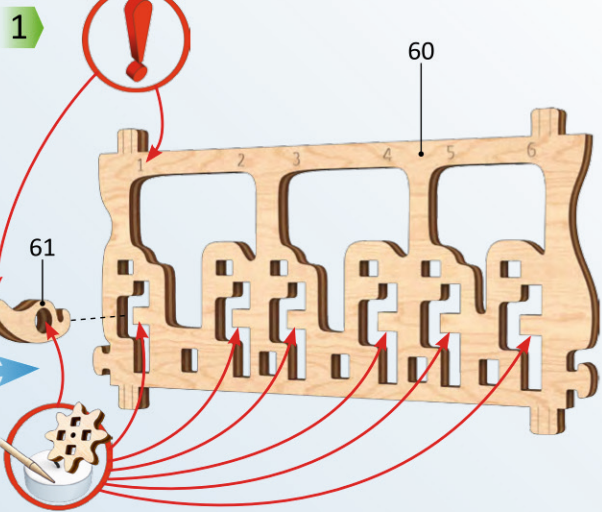
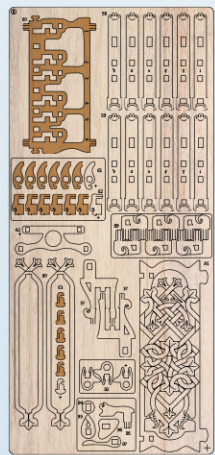

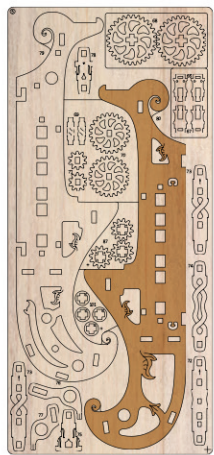

1

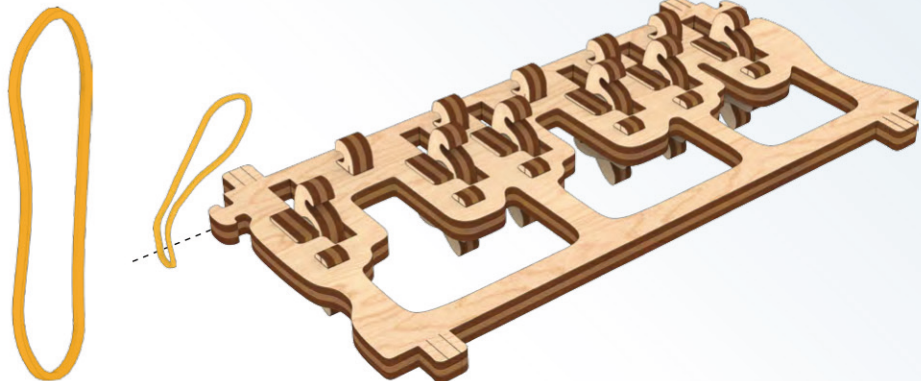

2

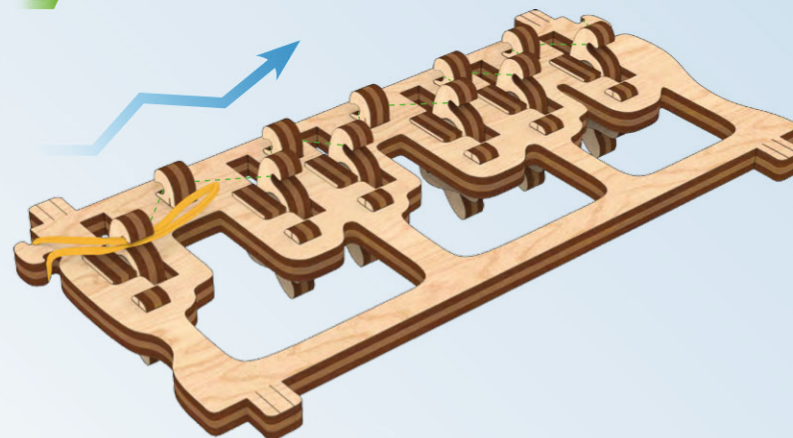

3

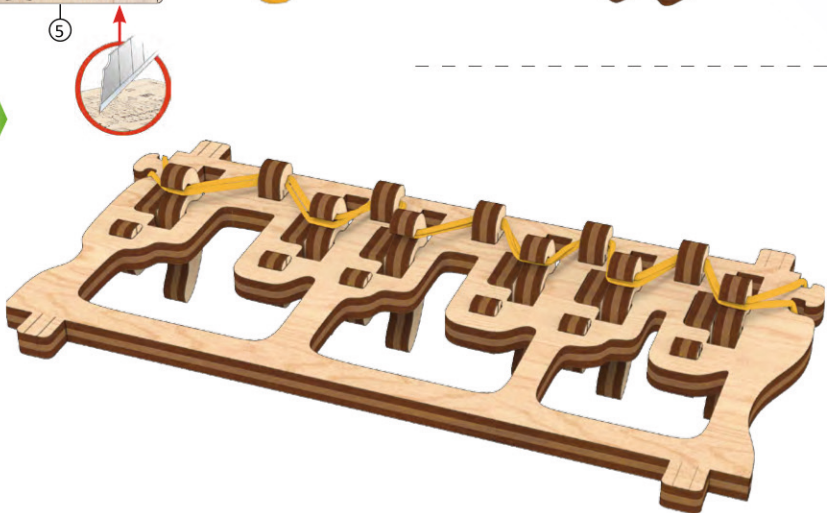

4

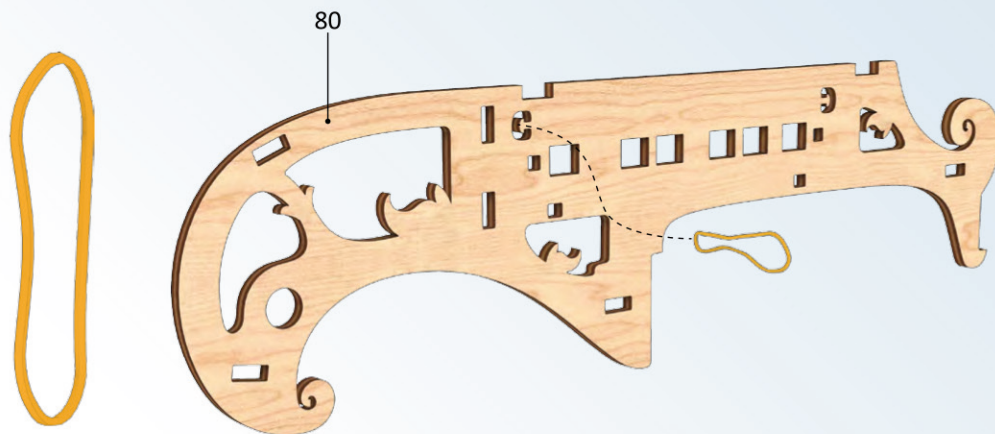

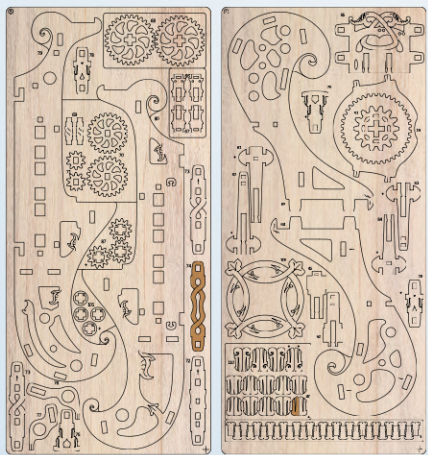

5

6

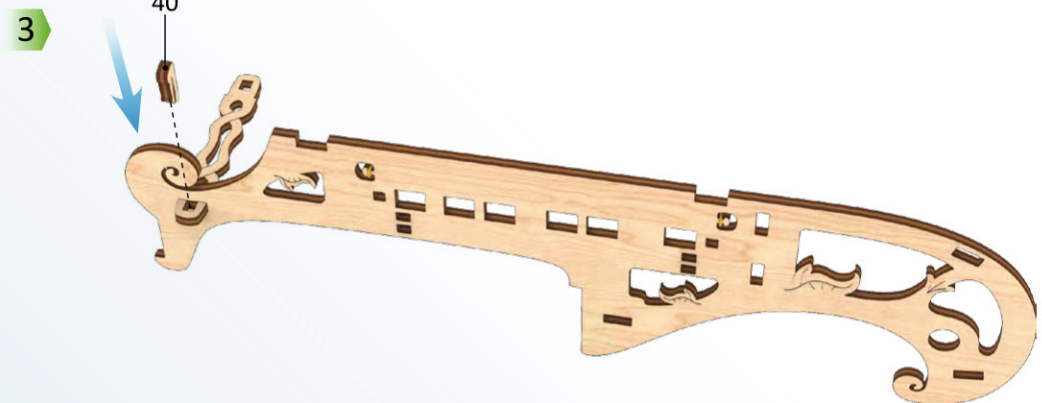
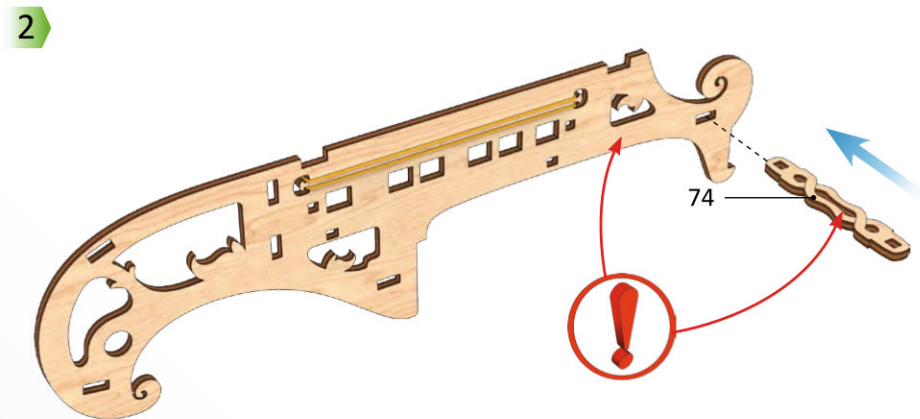
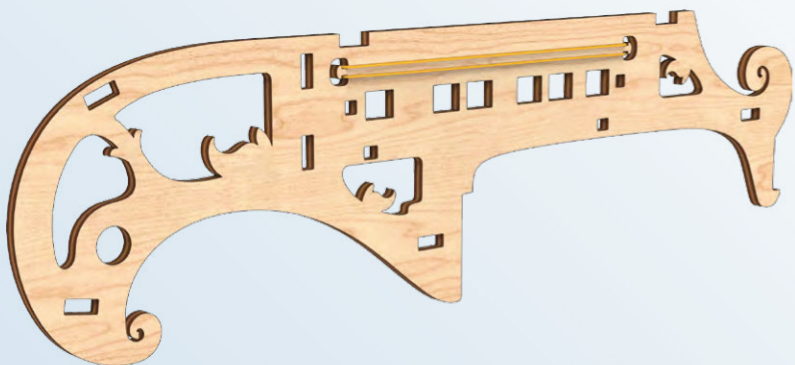
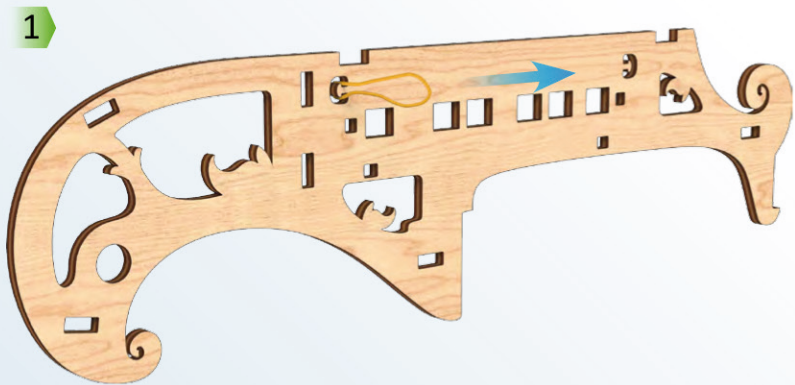

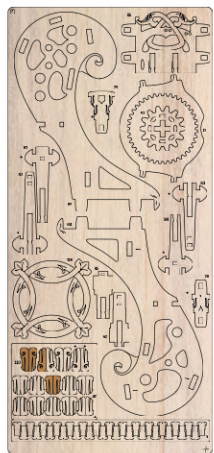

6

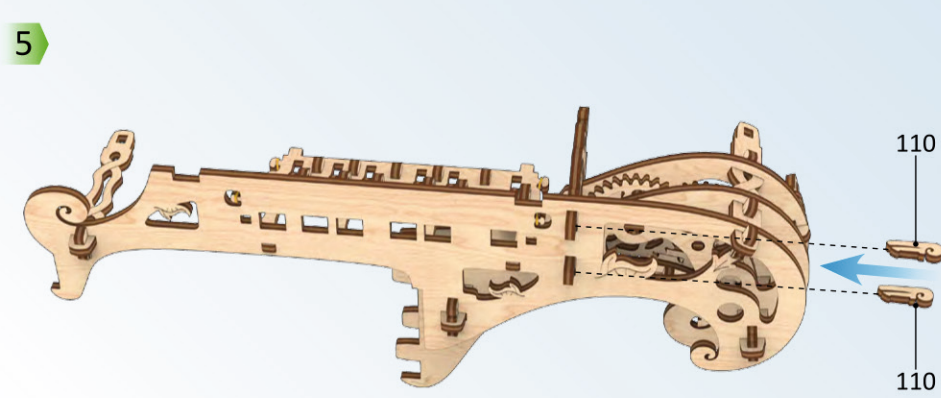
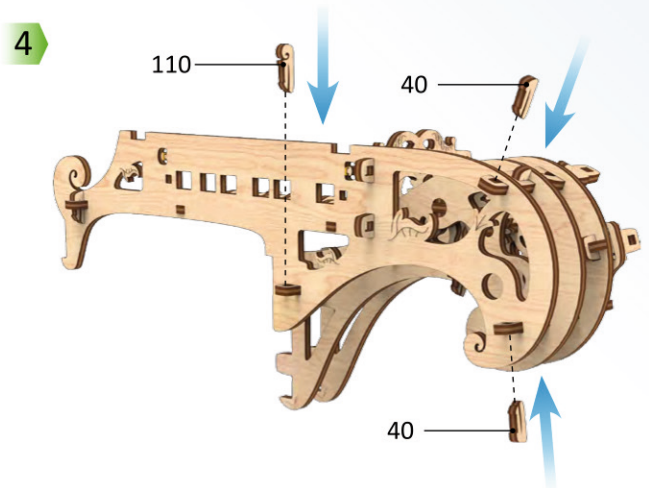
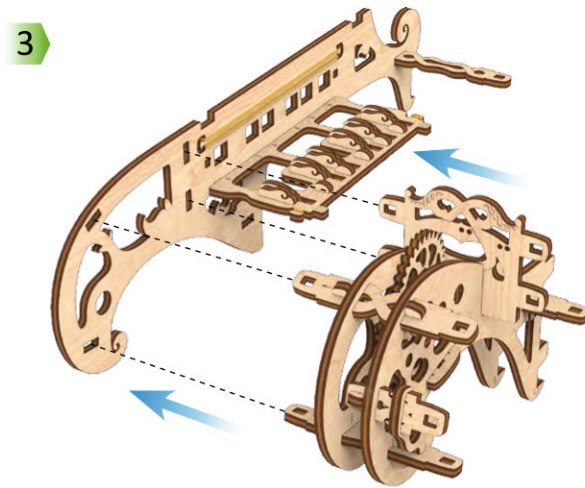
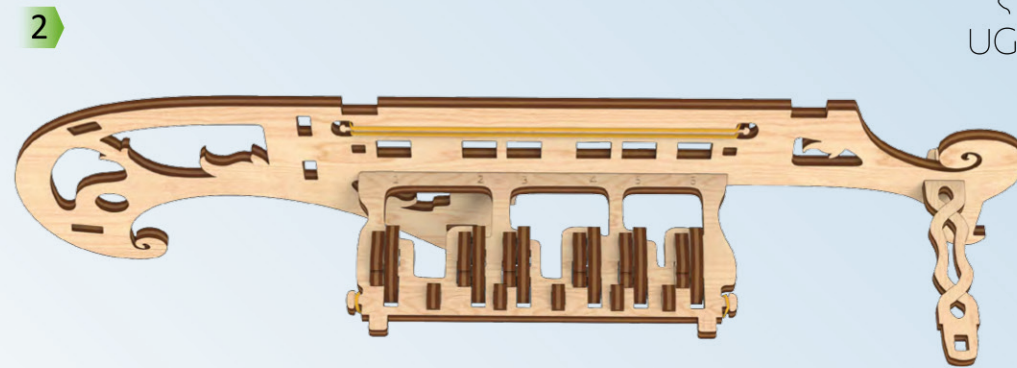
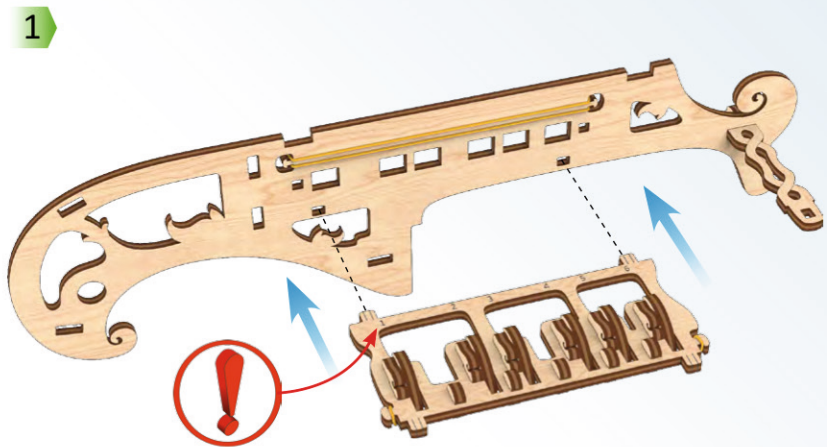

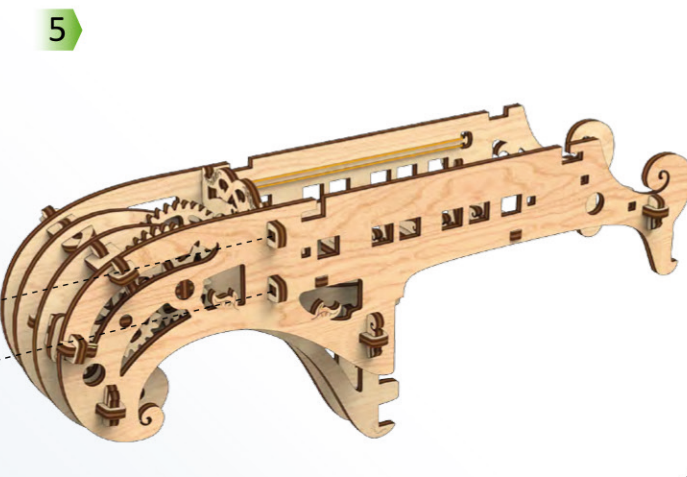
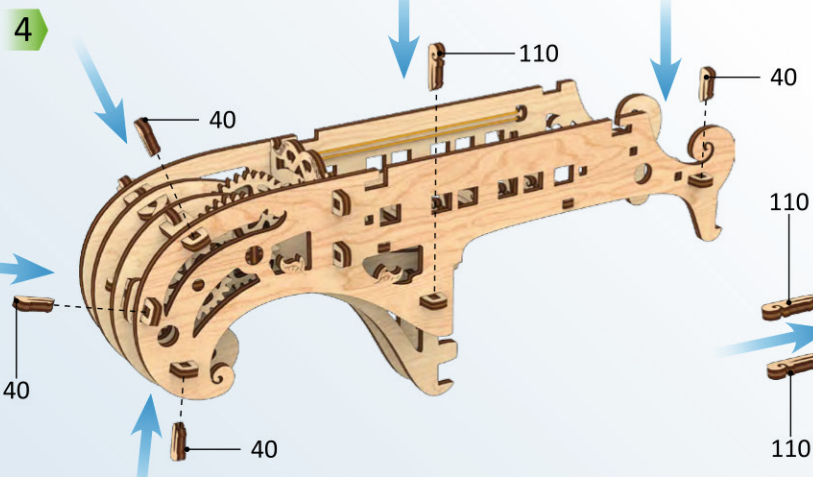
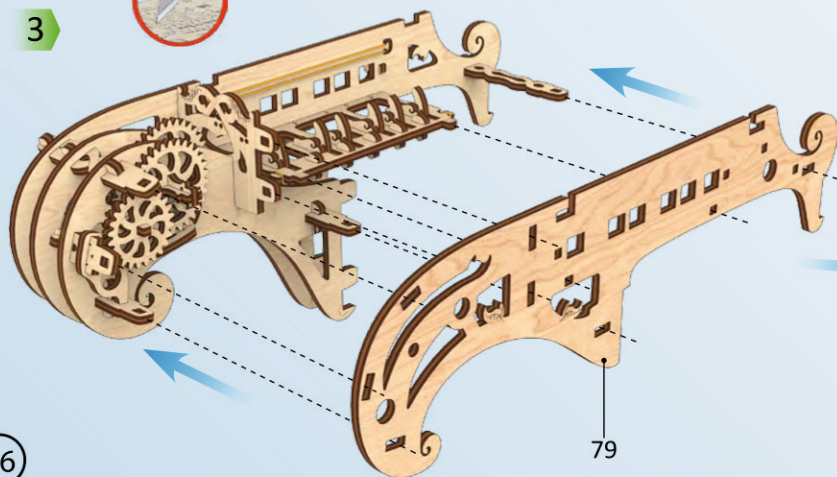
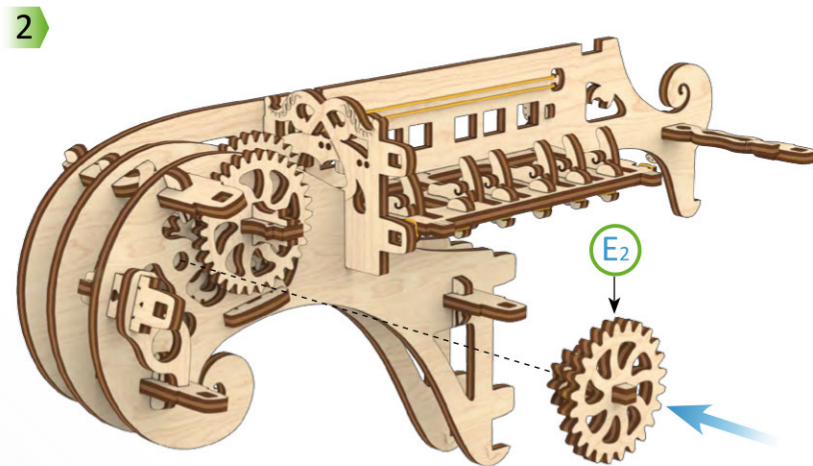
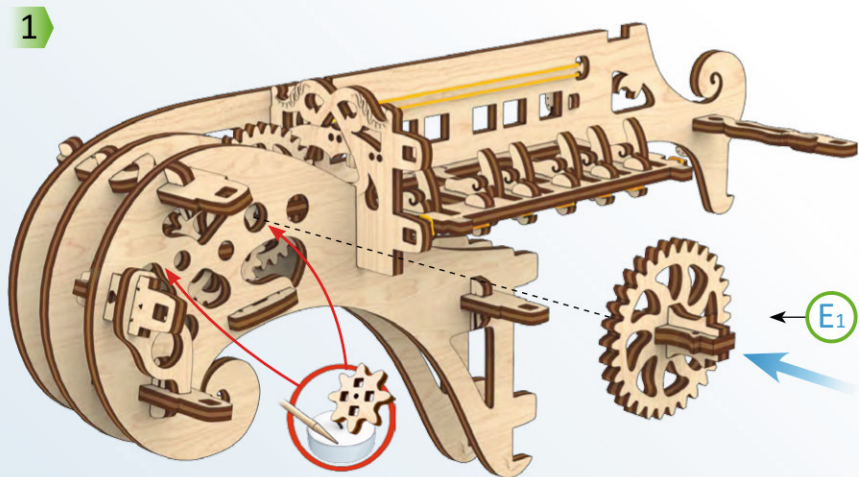
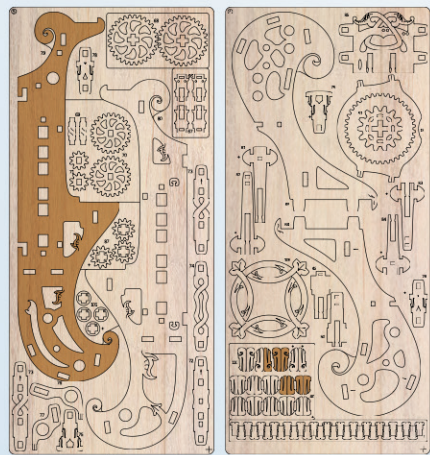

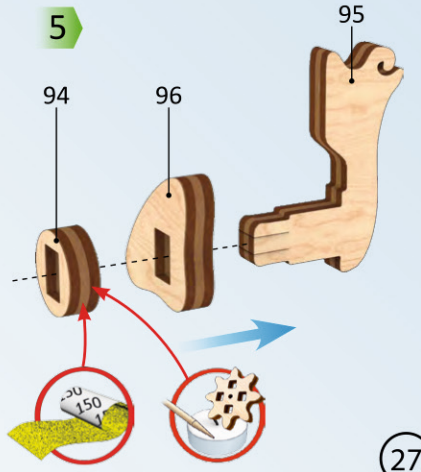
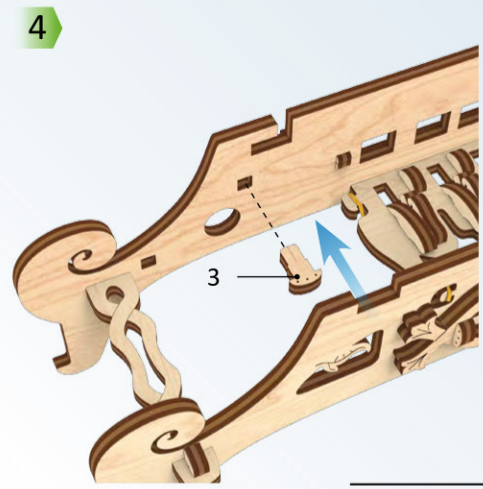
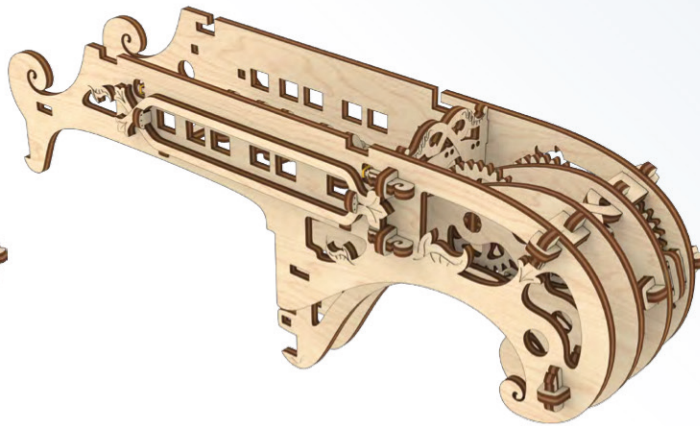
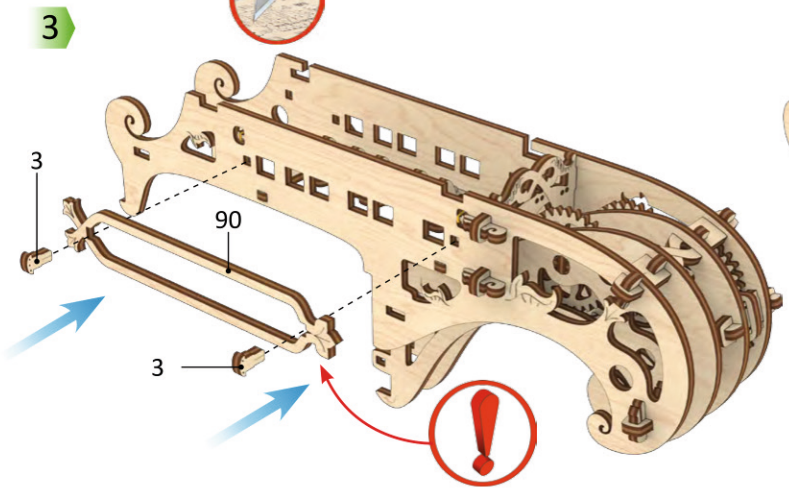
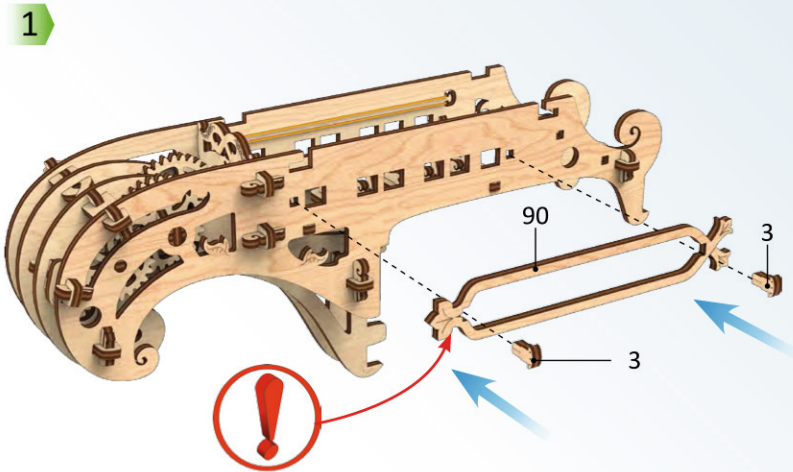
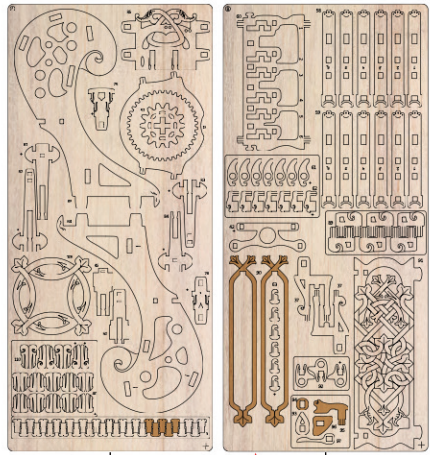

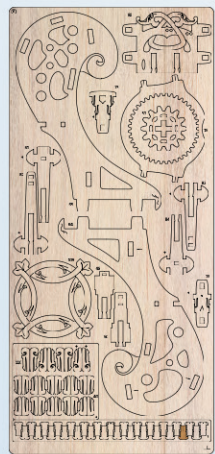

6

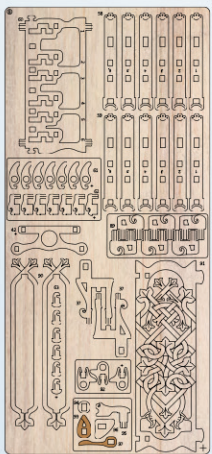

8

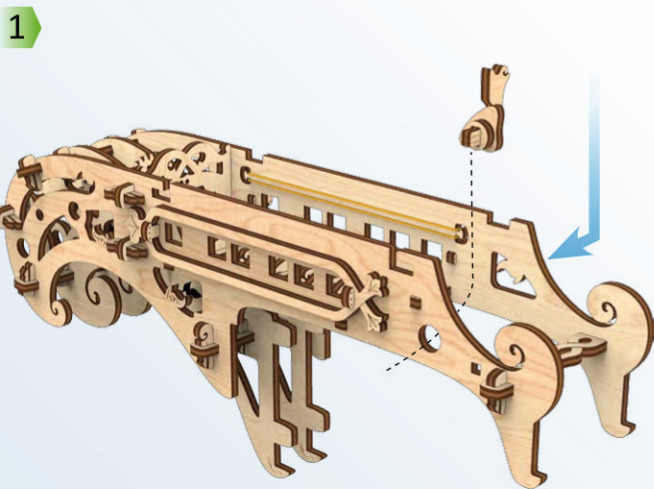

1

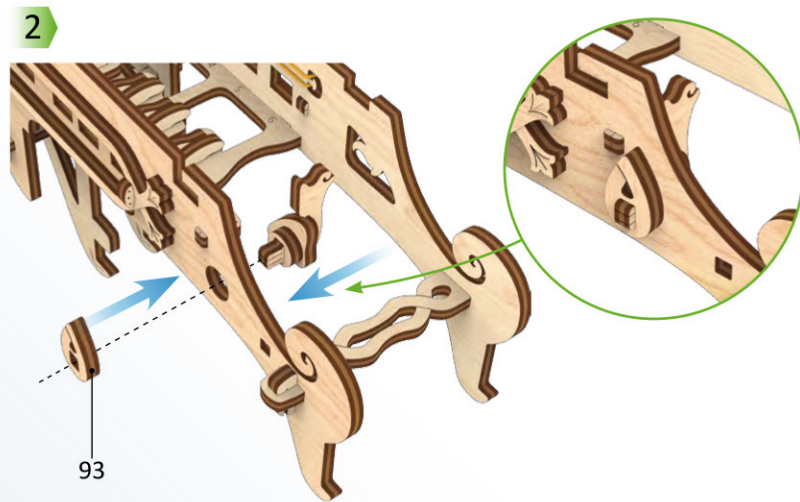

2

93

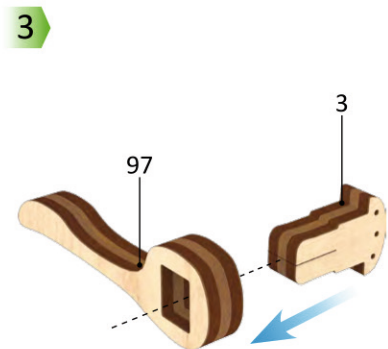

3

97

3



4

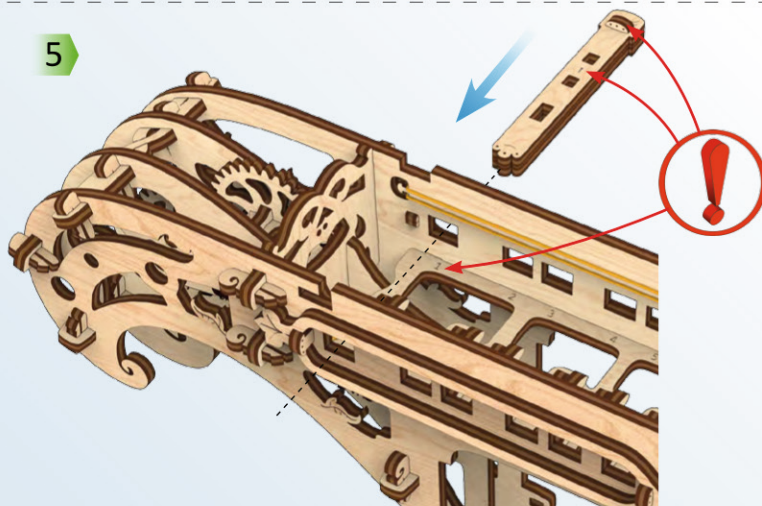

5

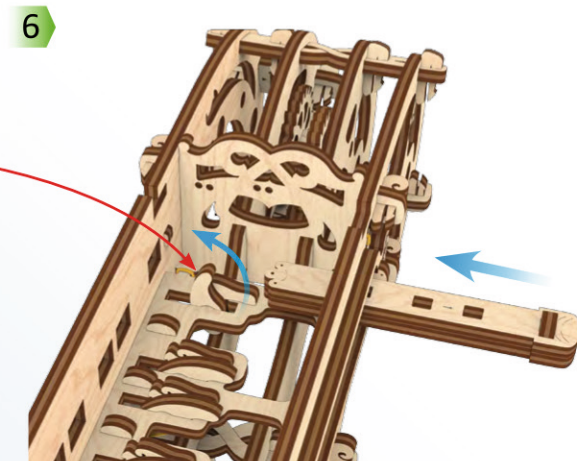

6

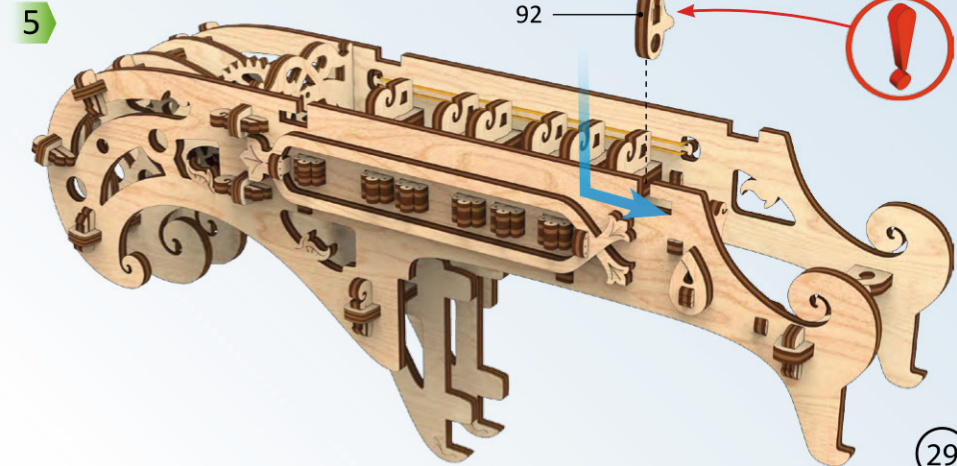
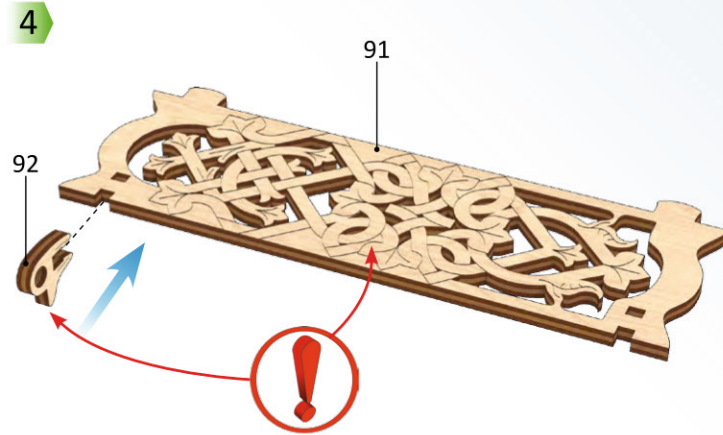
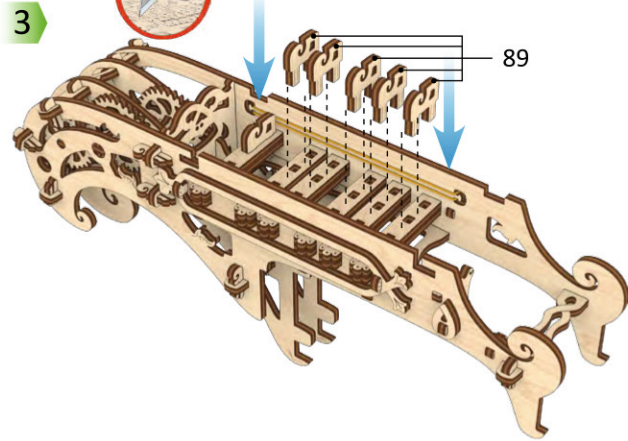
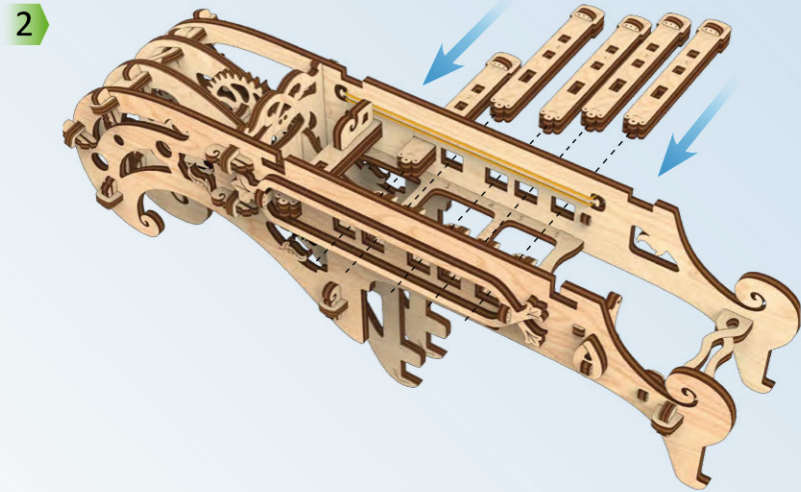
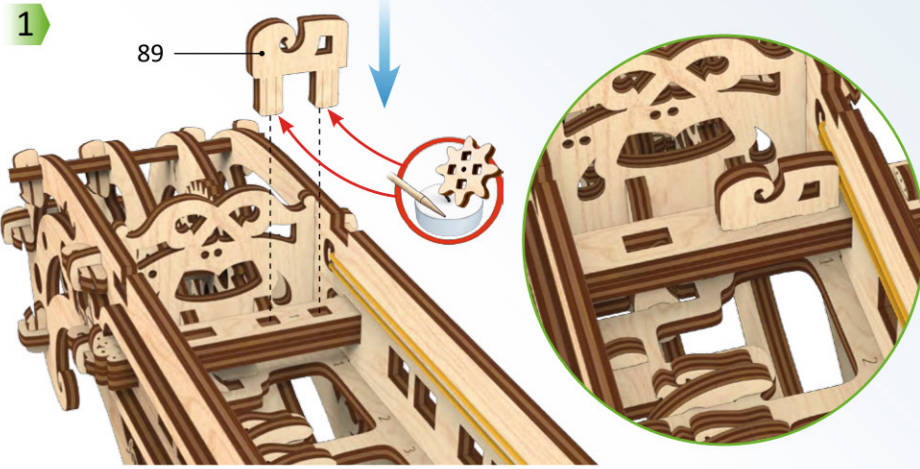
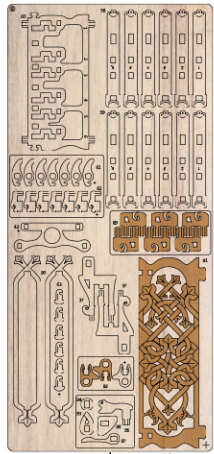



4

1

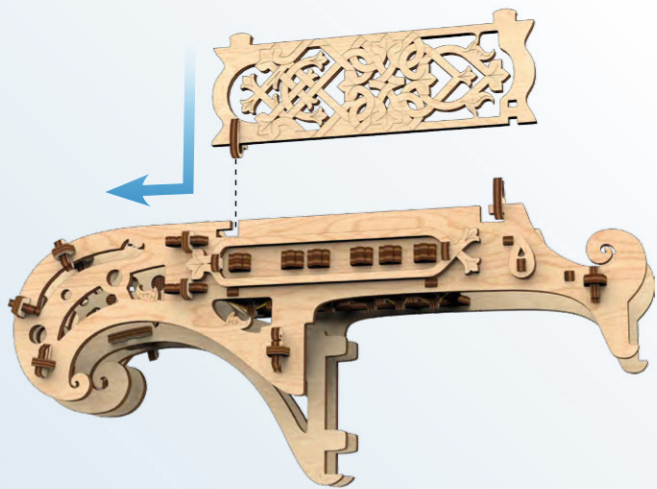

2

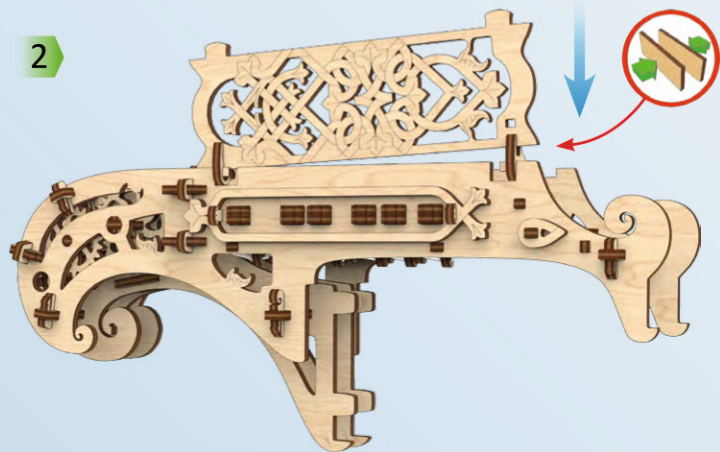

3

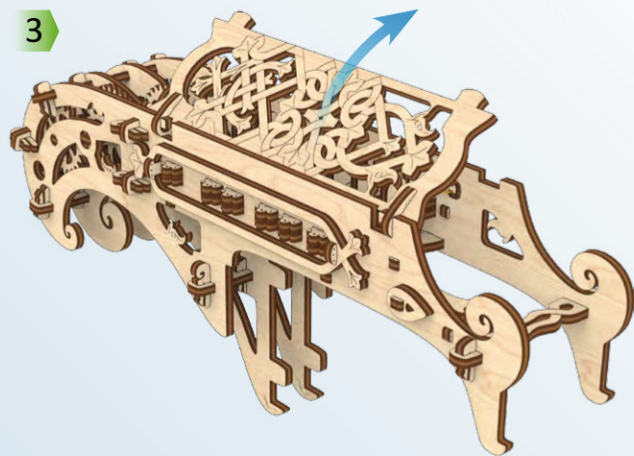

1

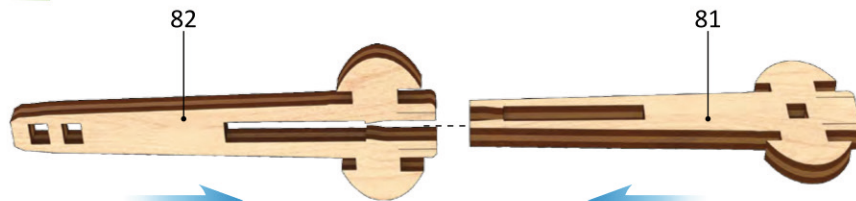

2

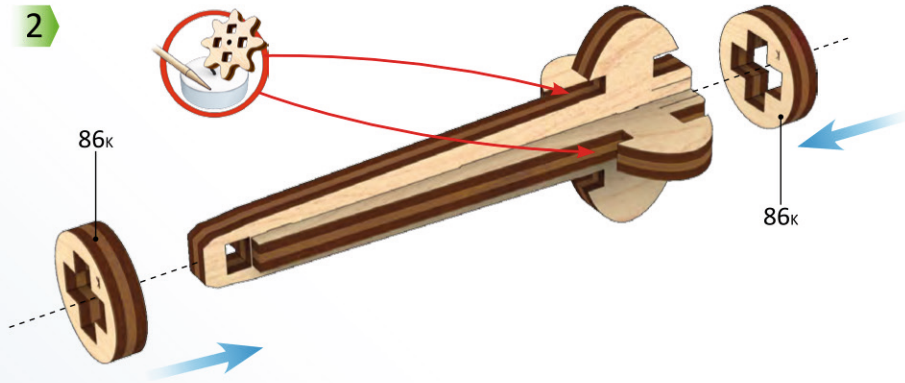

3



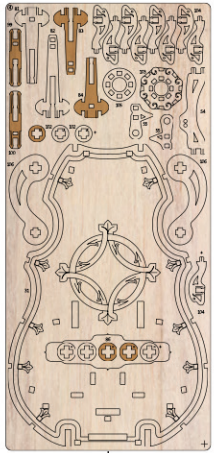

4

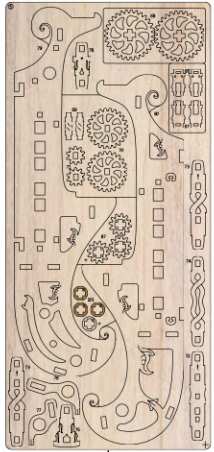

5

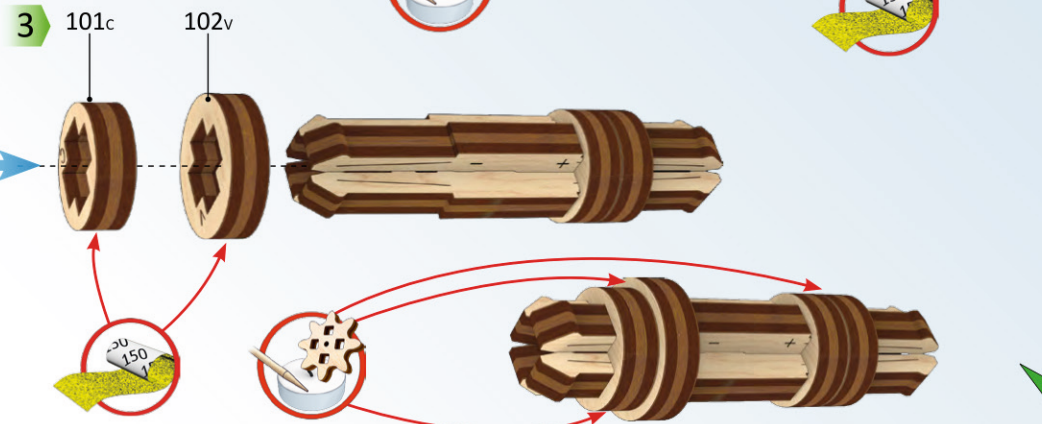
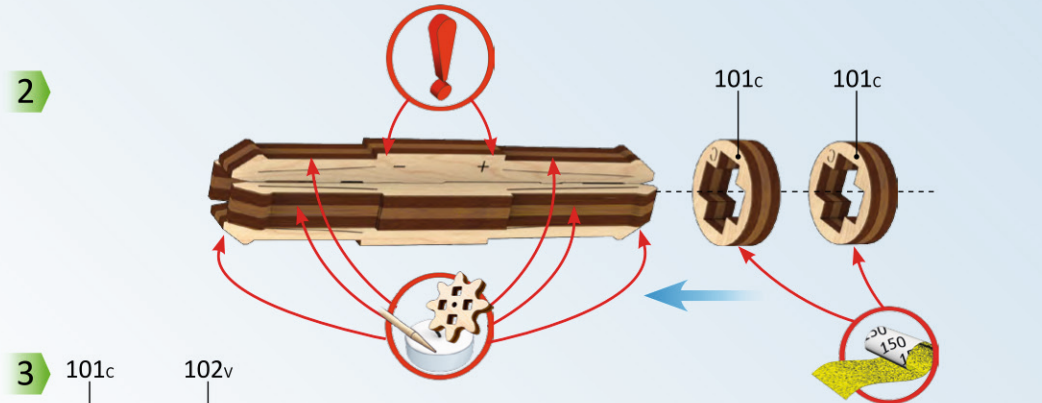
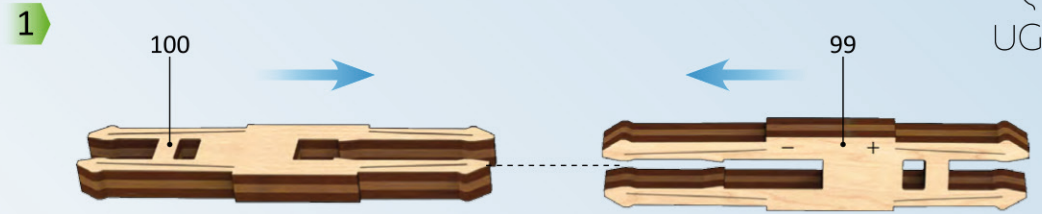
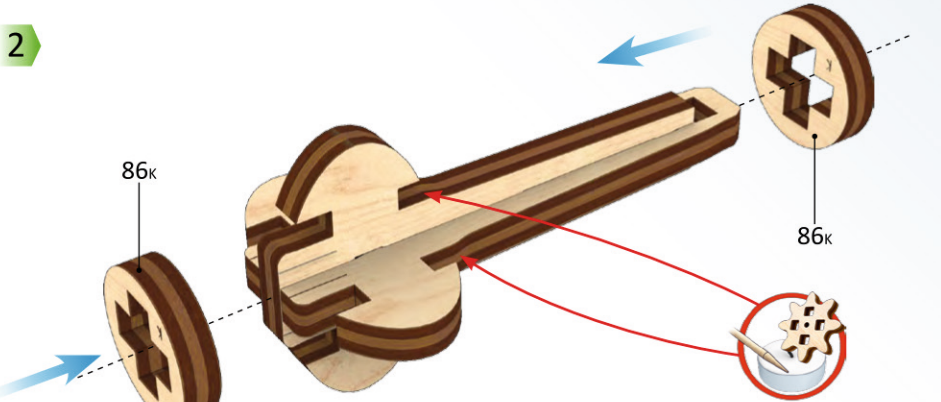
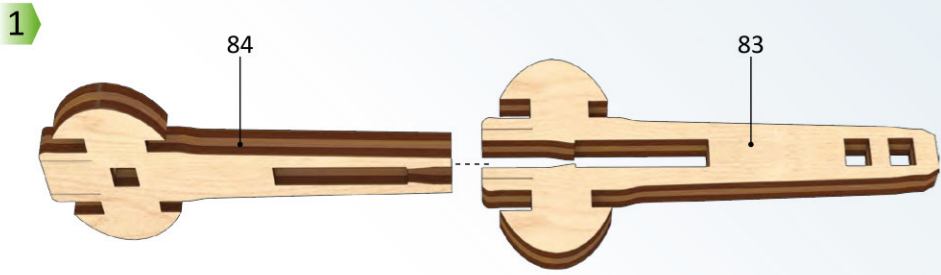

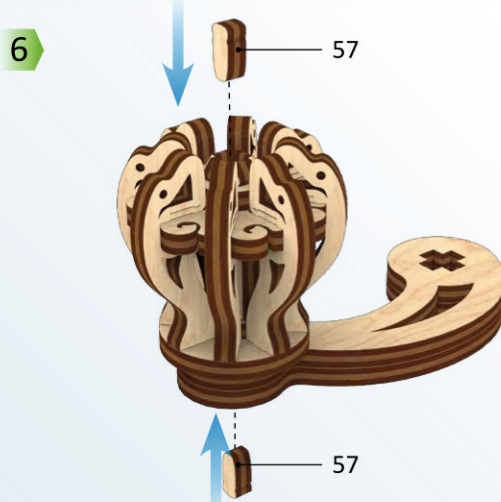
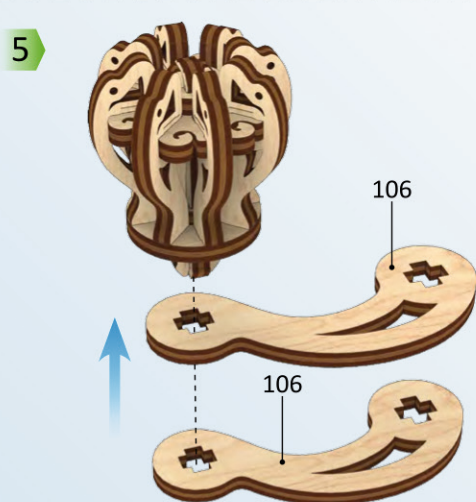
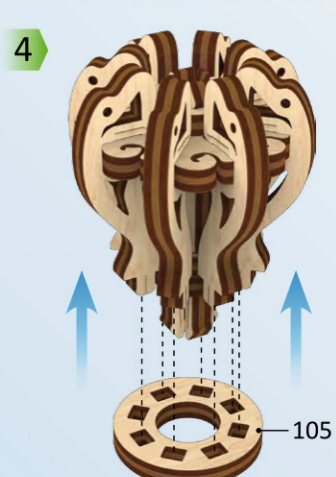
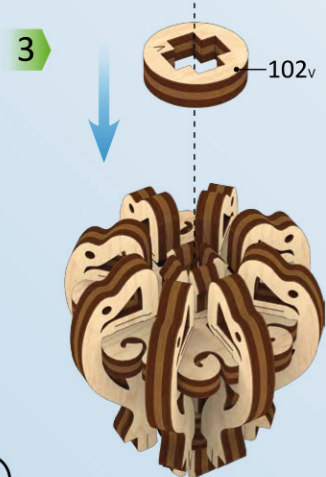
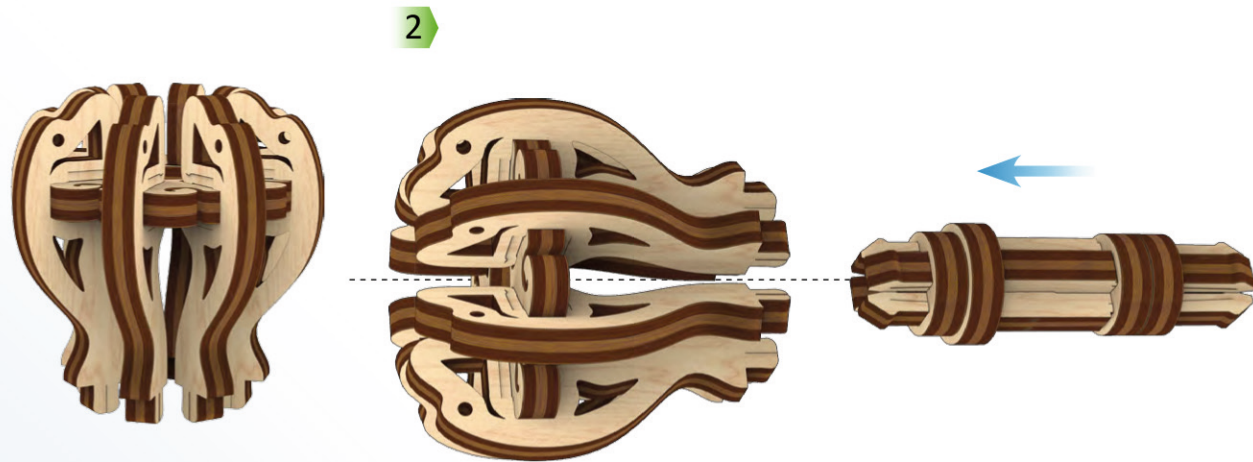
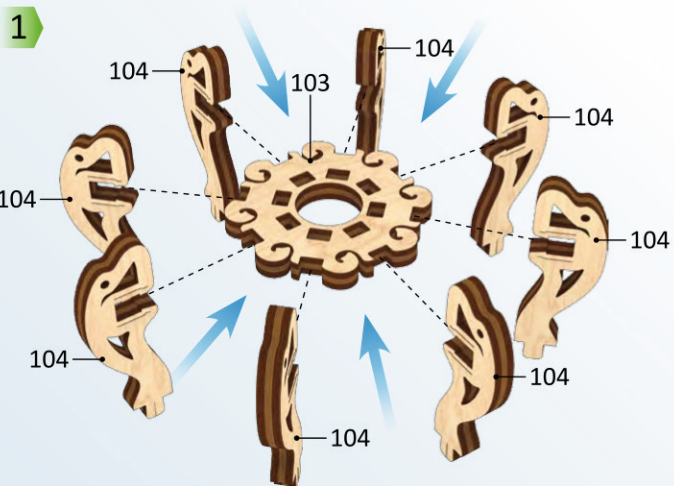
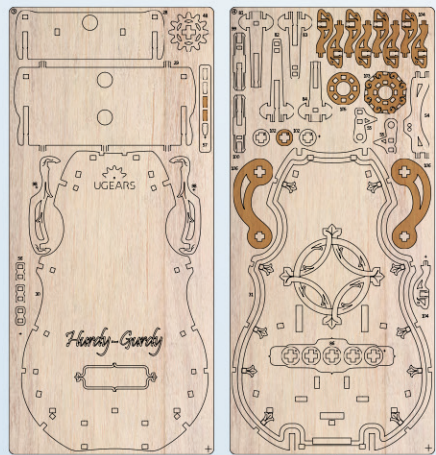

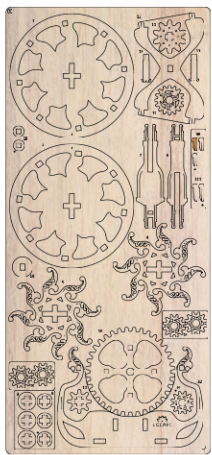

1

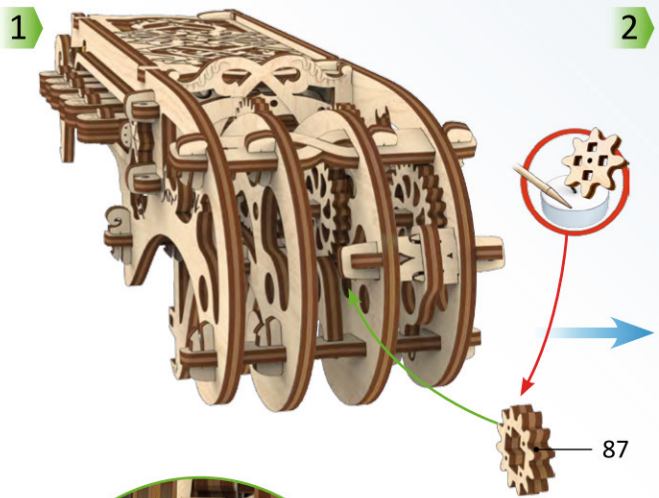

87



F_1

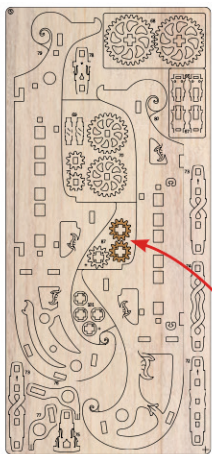

5

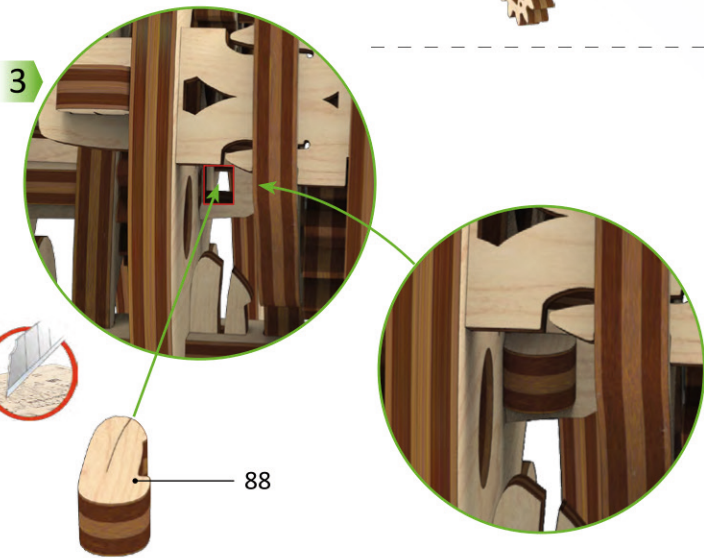

88

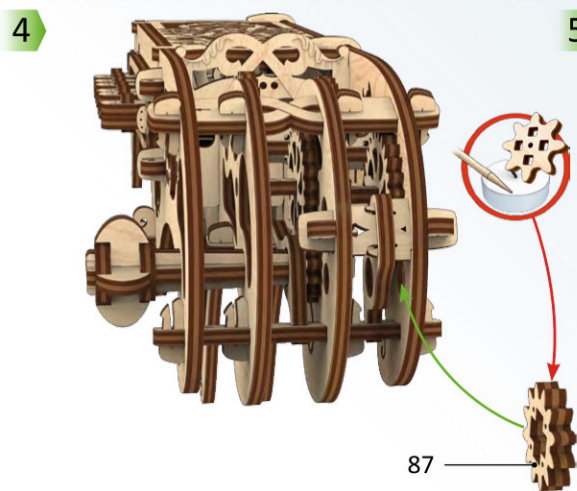

87

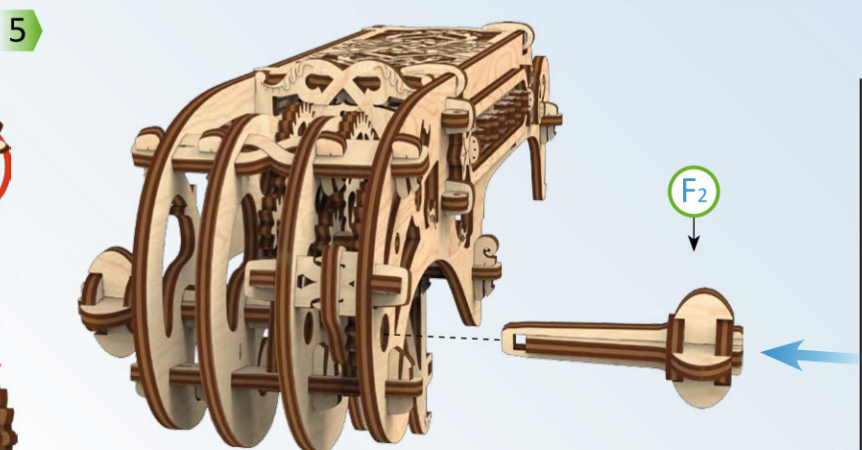

F_2

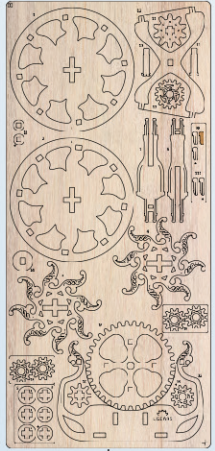

①

1

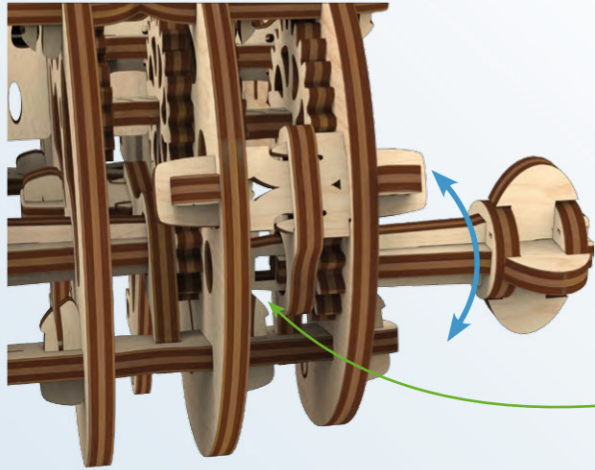

2

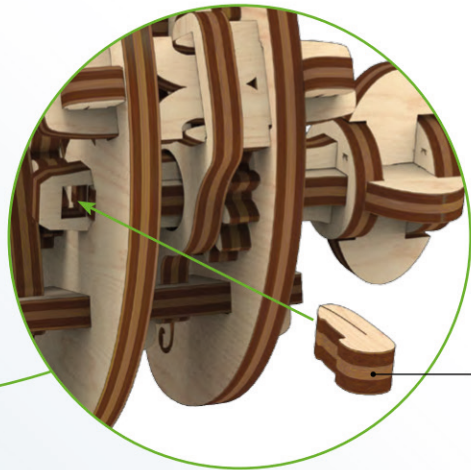

88

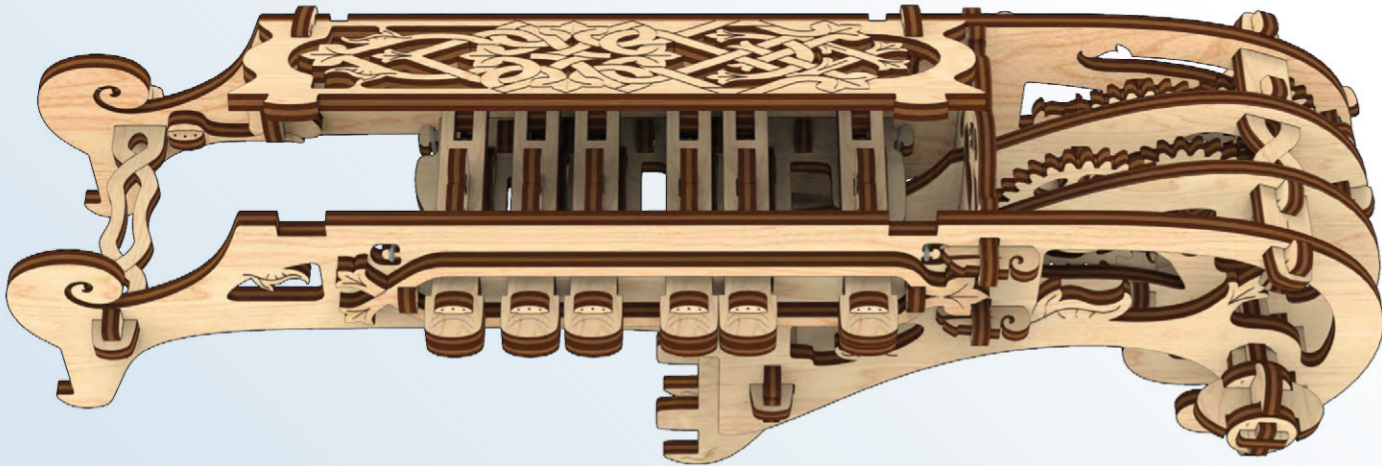

← H



1

H

2

D

1

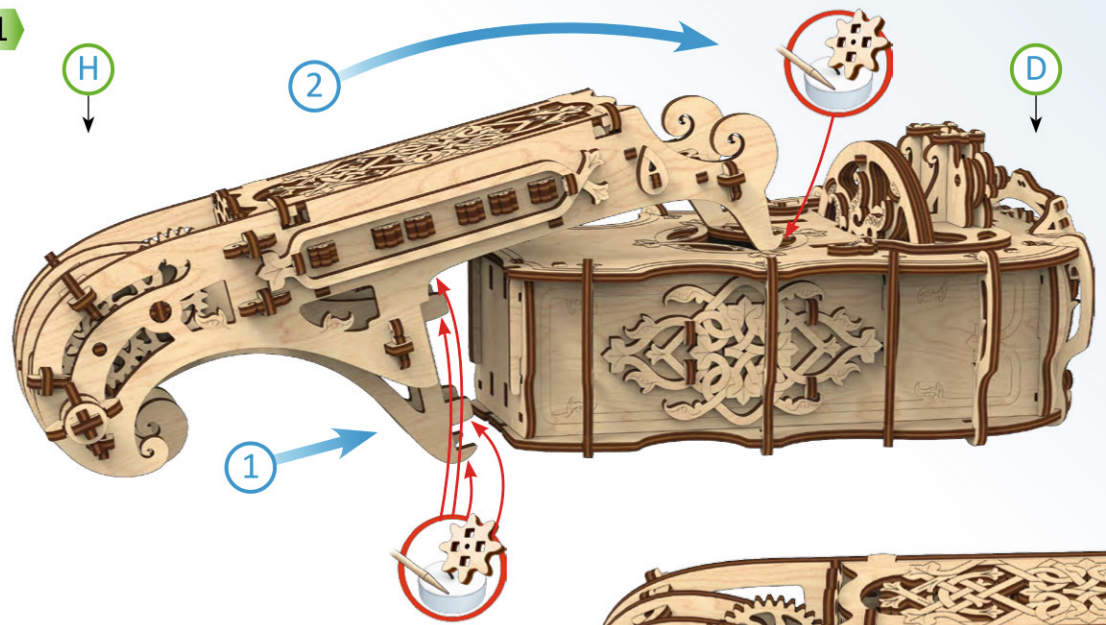

2

KLAC

KLAC

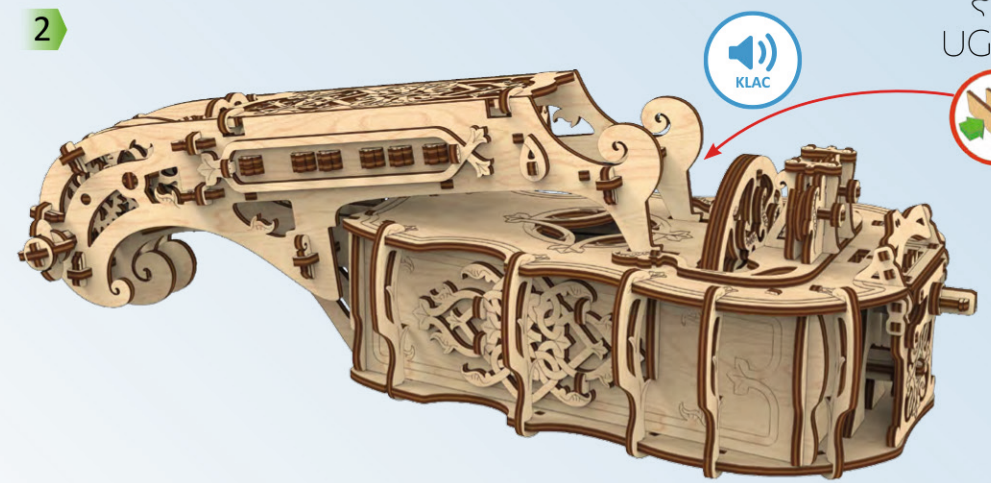

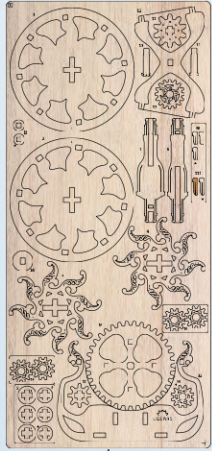

1

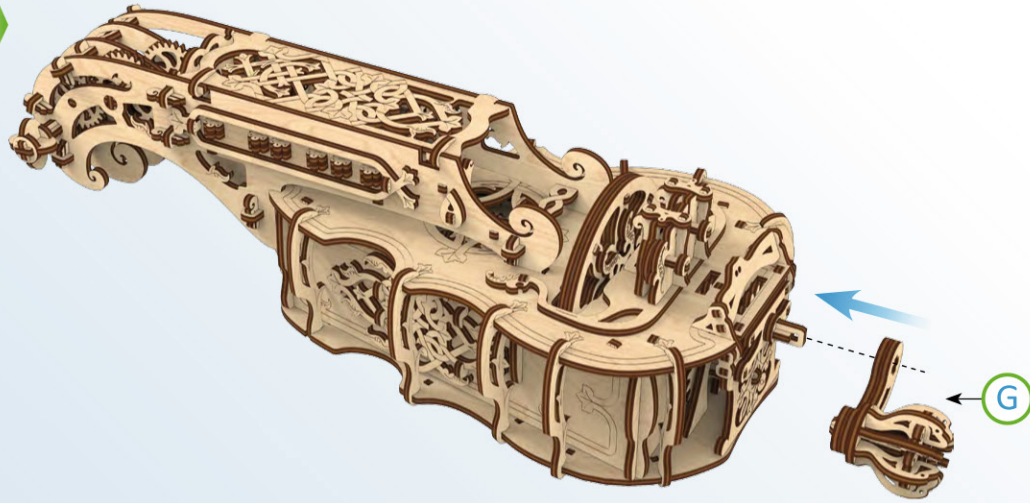

2



3

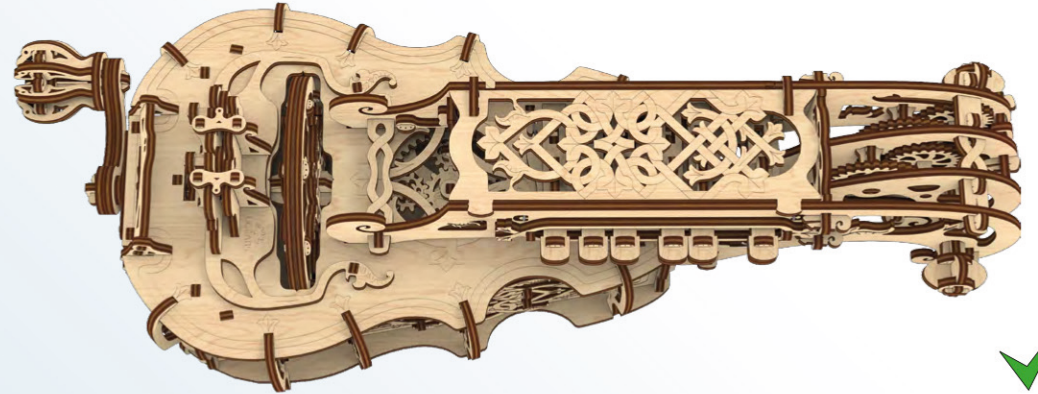

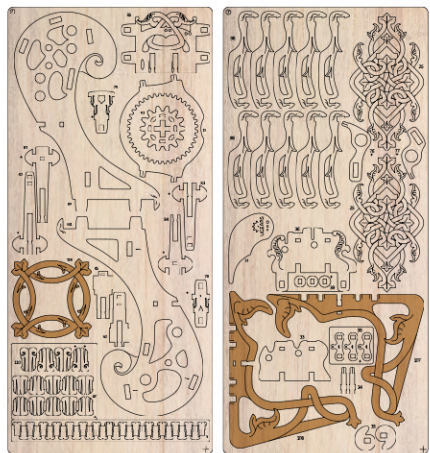

1

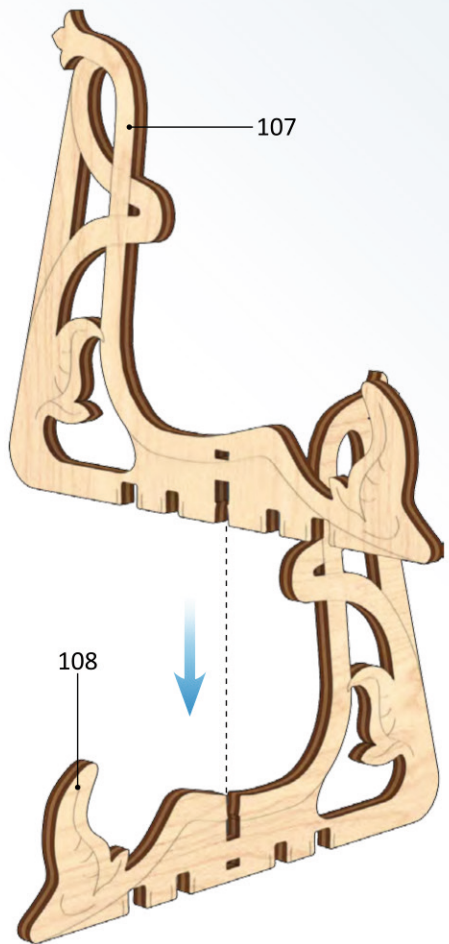

2

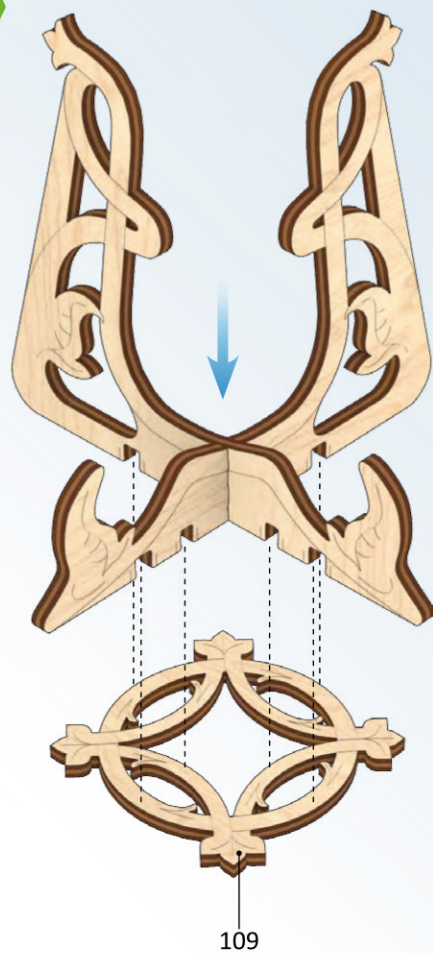

3

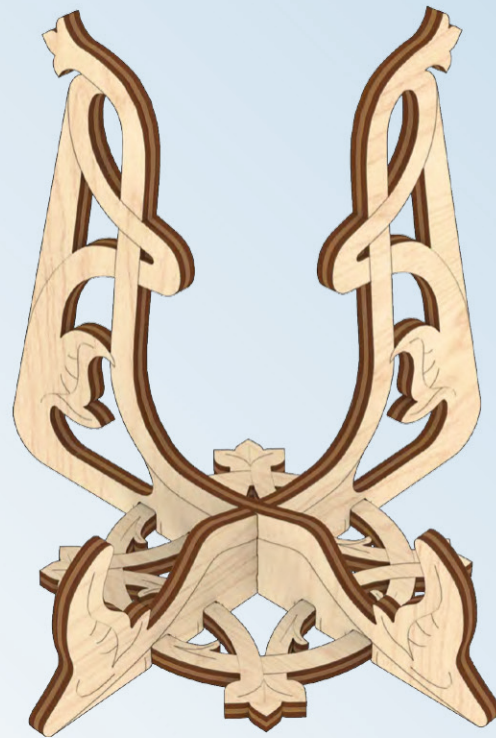

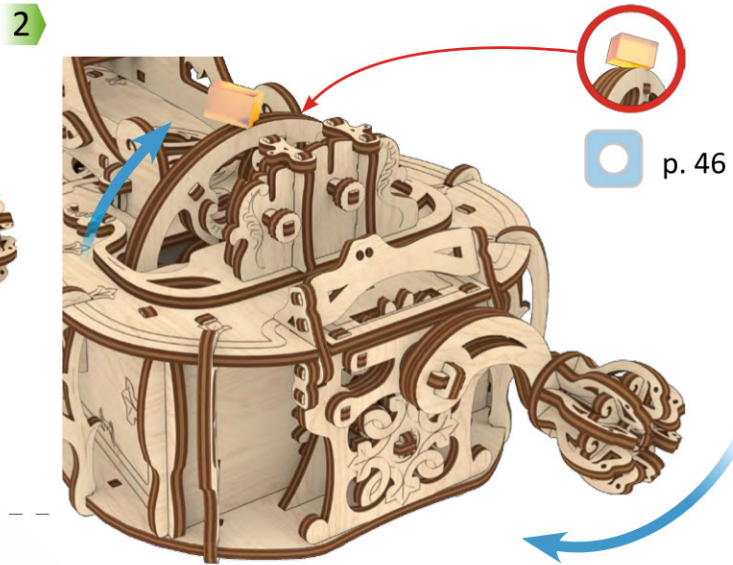
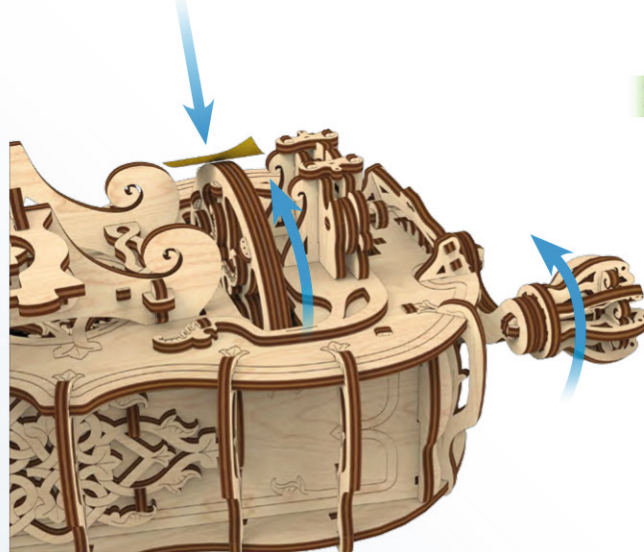
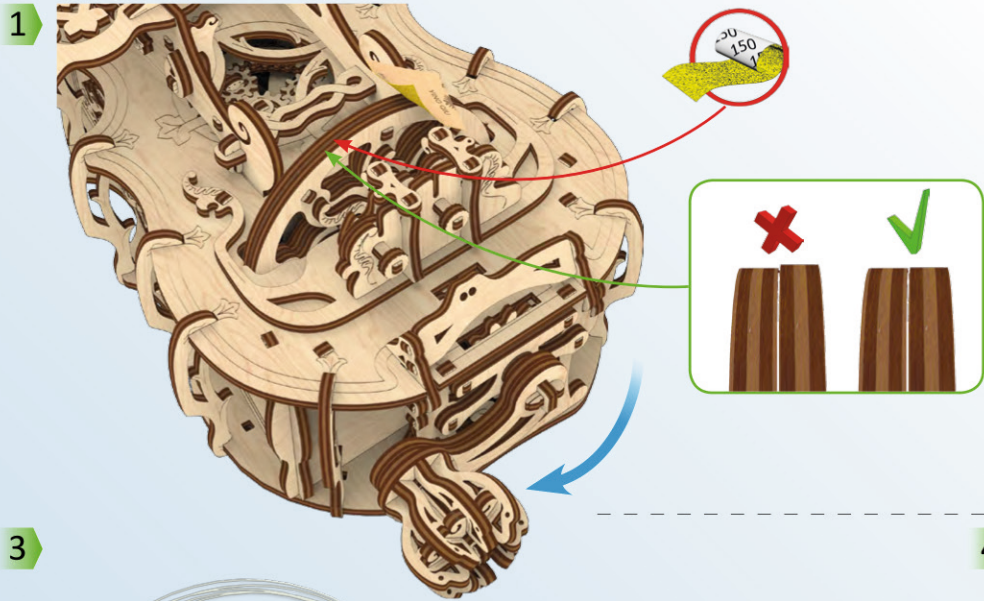

ENG Use the fishing line supplied. **UKR** Використовуйте ліску з комплекту. **DEU** Nutzen Sie die Angelschnur aus dem Bausatz. **FRA** Utilisez le fil fourni dans le kit. **POL** Użyj żyłki z zestawu. **SPA** Use el léxico de la unidad. **ITA** Usate la lenza dal kit. **TUR** Takımda olan misinayı kullanınız. **RUS** Используйте леску из комплекта. **KOR** 키트에서 낚시 줄을 사용합니다. **CHI** 请使用提供的钓鱼线。

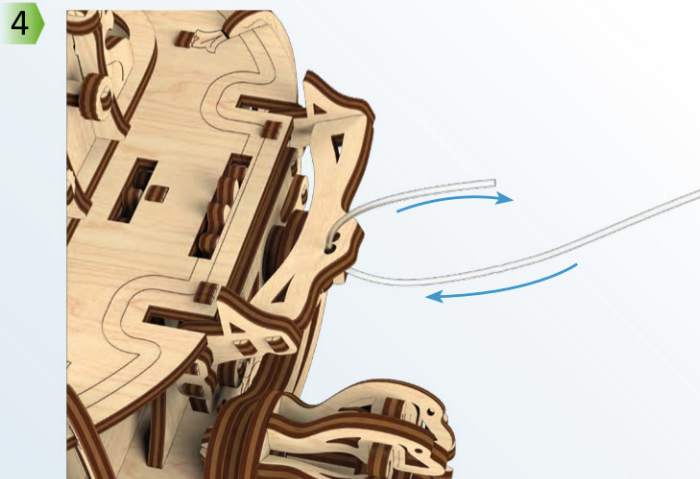

ENG Attention! Do not confuse. Attention! The set includes rosin - it is used to increase the friction of the treated surface of the part! **UKR** Увага! Не переплутайте. У набрі є канифоль, для підвищення тертя поверхнь. **DEU** Achtung! Verwechslungsgefahr. Achtung! Kolophonium im Lieferumfang – wird dazu verwendet die Reibung der damit behandelten Oberflächen zu erhöhen. **FRA** Attention! Ne pas confondre. Attention! Dans la boîte est inclus de la résine (colophane) - utilisée pour augmenter le frottement de la surface traitée! **POL** Uwaga: Nie pomył się! Uwaga: Zestaw zawiera kalafonię, używaną do zwiększenia tarcia na powierzchni elementu. **SPA** ¡Atención! No se debe confundir. ¡Atención! El paquete incluye la colofonia - se utiliza para aumentar la fricción de la superficie tratada de la pieza! **ITA** Attenzione! Non confondere. Attenzione! Il set include colofonia - da utilizzare per aumentare l'attrito della superficie trattata! **TUR** Dikkatlice inceleyiniz lütfen / Karışıklığa karşı dikkat! Dikkat! Komple set reçine içerir - işlenmiş parça yüzeyinin sürtünmesini arttırmak için kullanılır! **RUS** Внимание! Не перепутайте. В комплект входит канифоль, для увеличения поверхностного трения. **KOR** 주의! 혼동하지 말 것. 주의! 세트안에 부품 표면의 마찰력을 높이기 위한 송진가루가 포함되어 있음. **CHI** 注意! 不要混淆。注意! 该组合包含松香-它用来提高处理过的部件表面的摩擦!

1

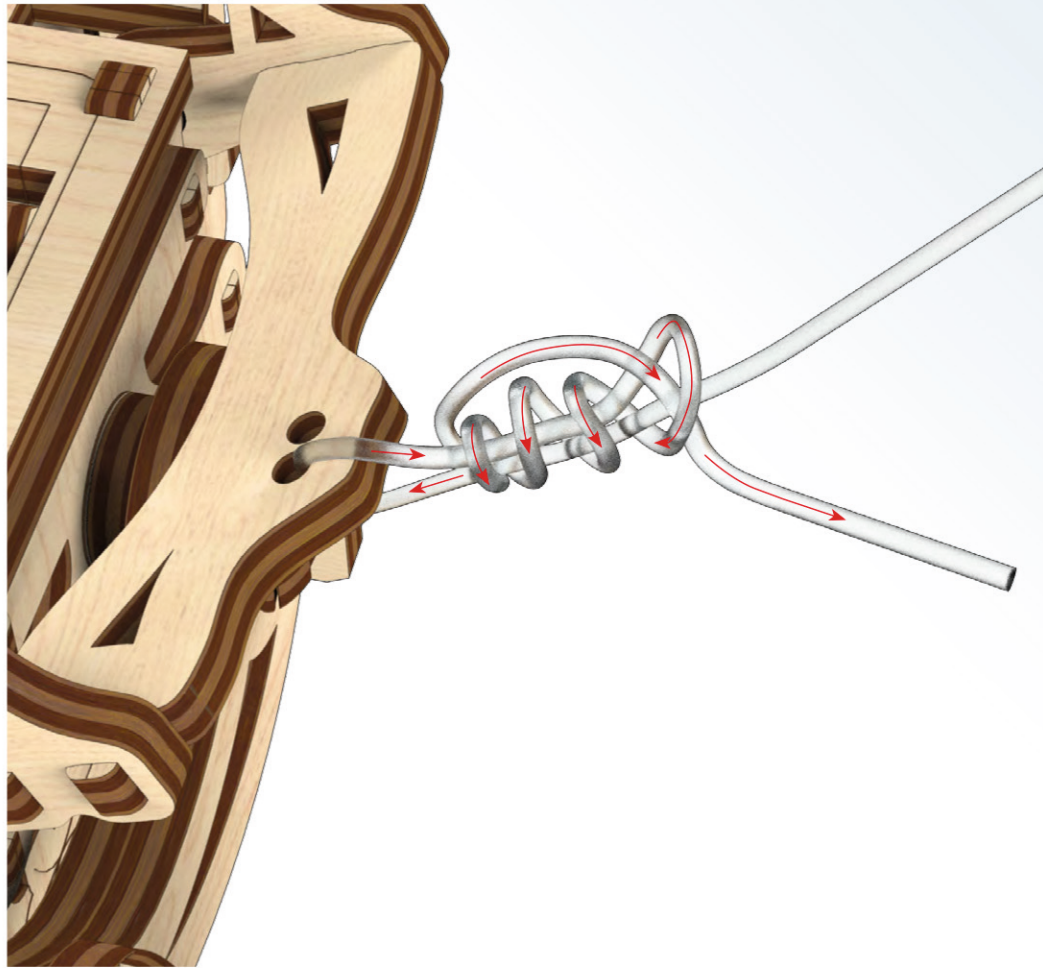

2

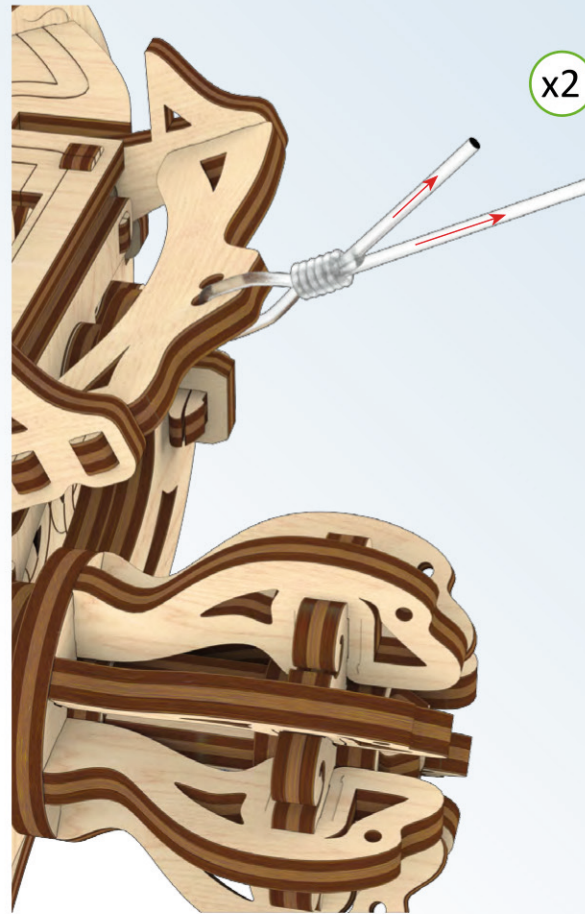

3

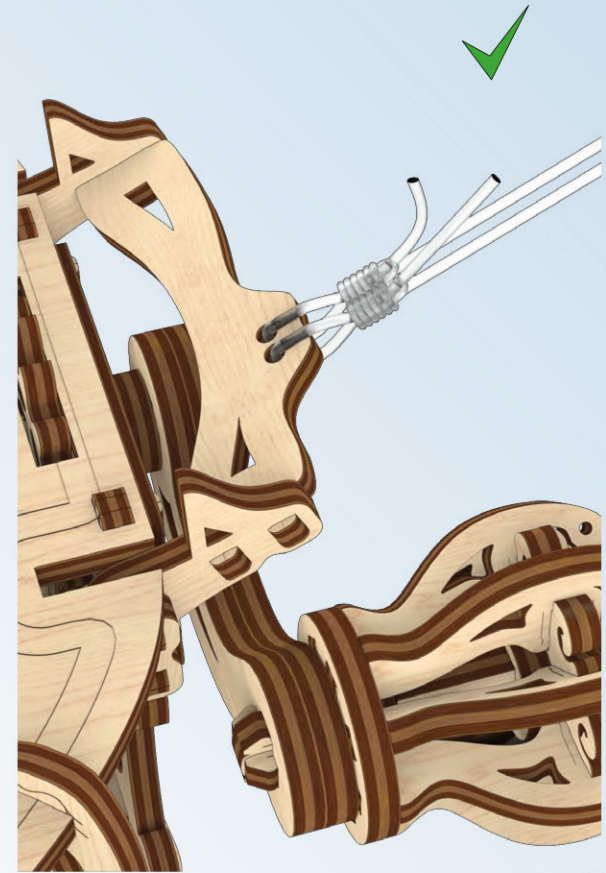

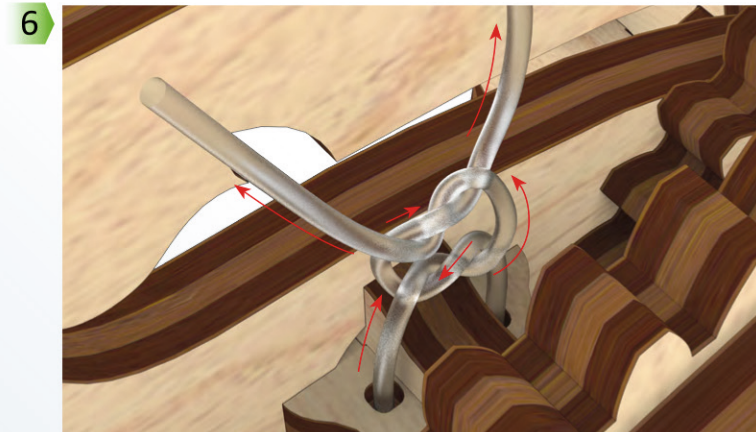
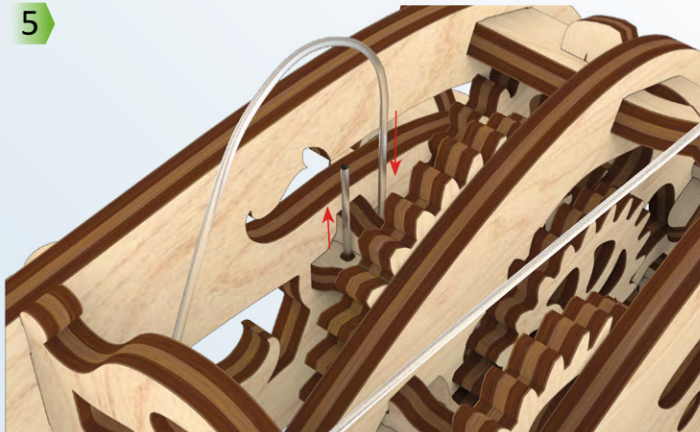
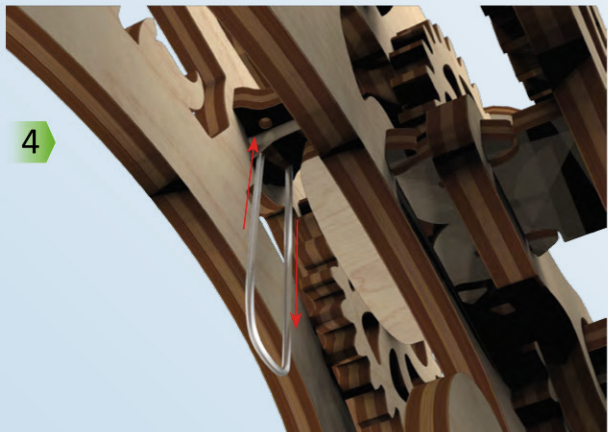
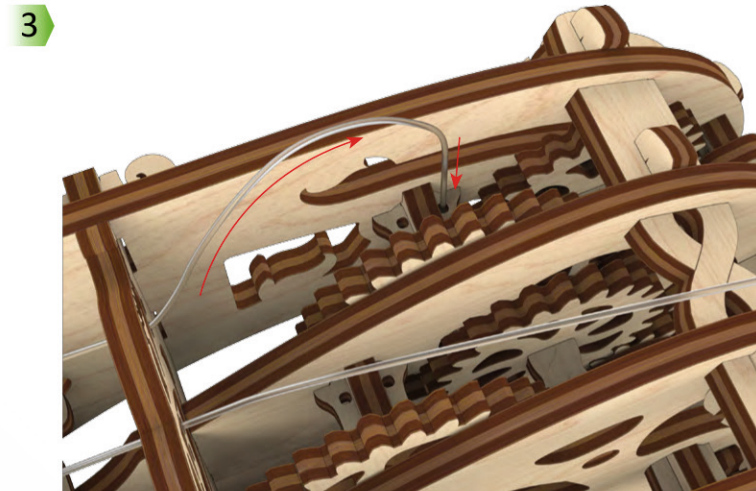
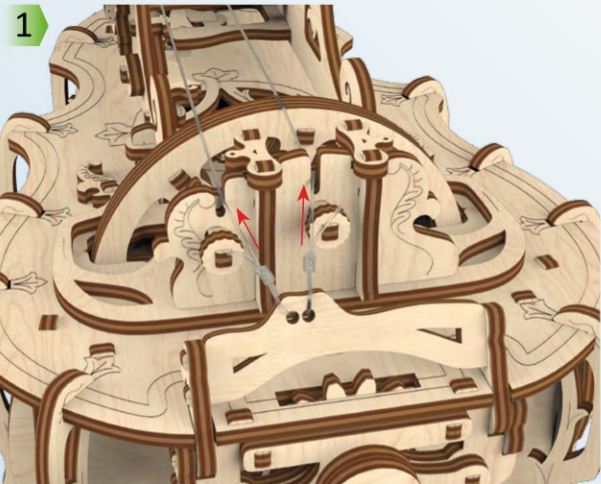

7

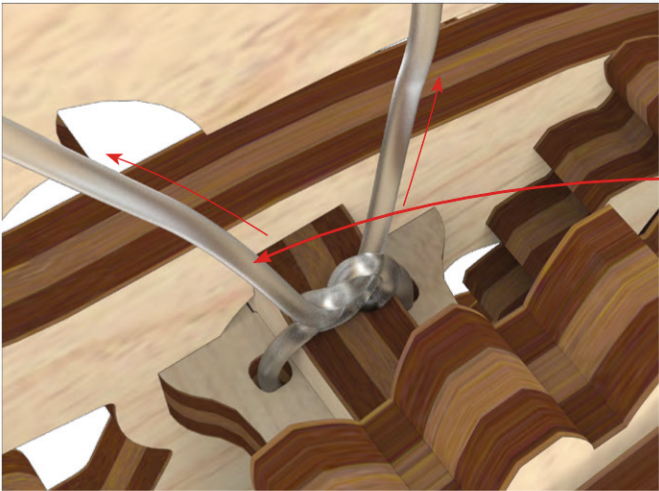

8



9

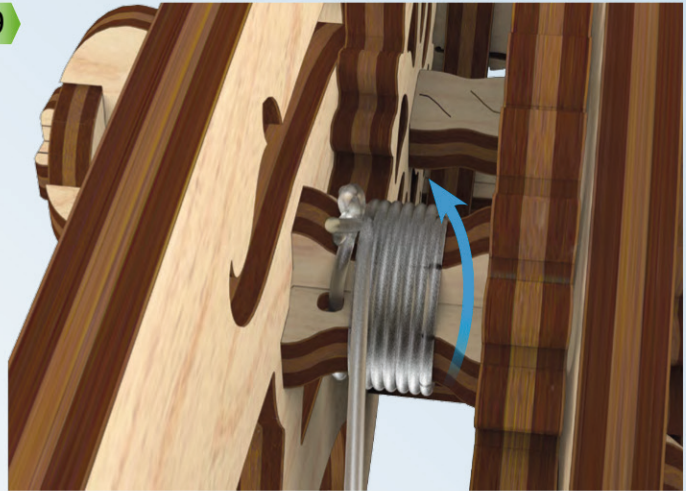

10

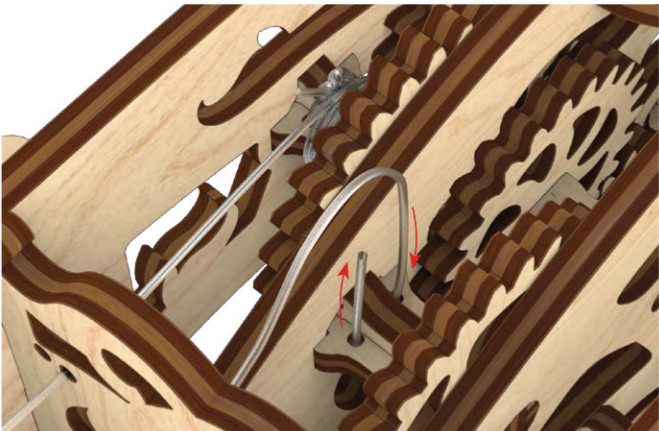

11

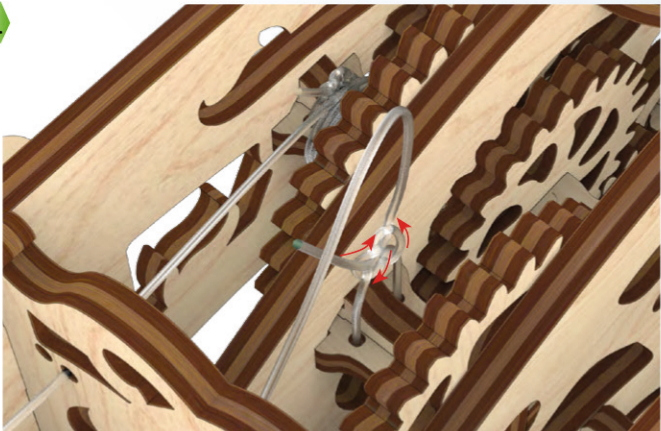

12





www.ugearsmodels.com/hurdy-gurdy

13

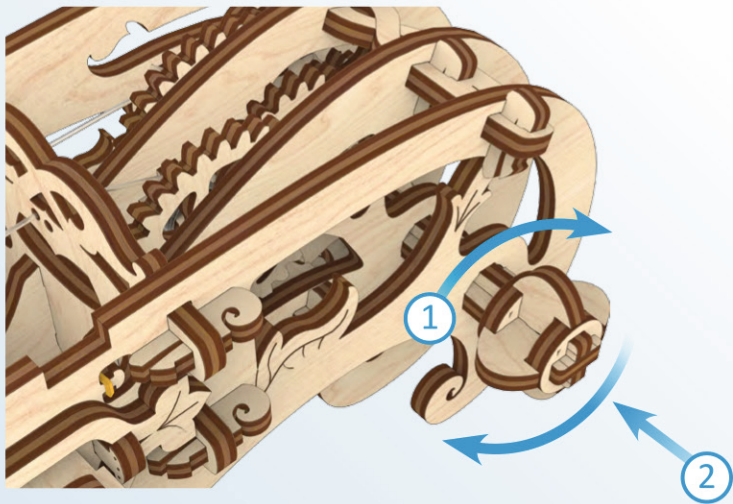

14

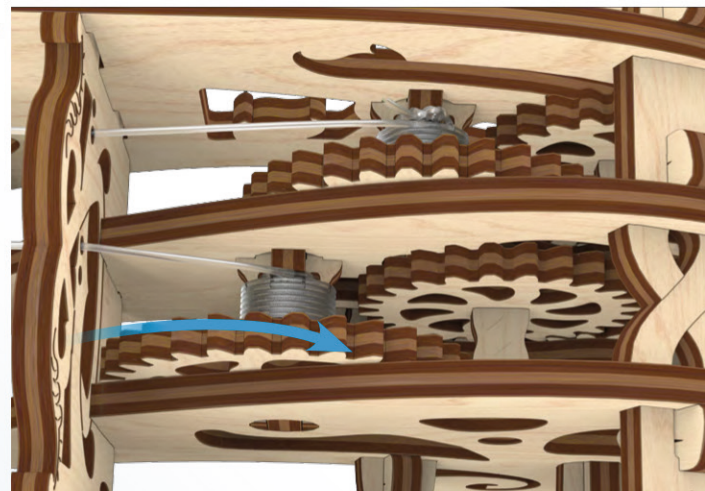

15

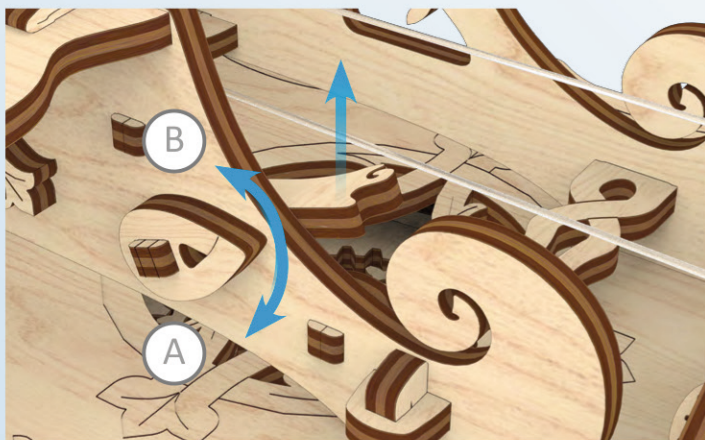

16

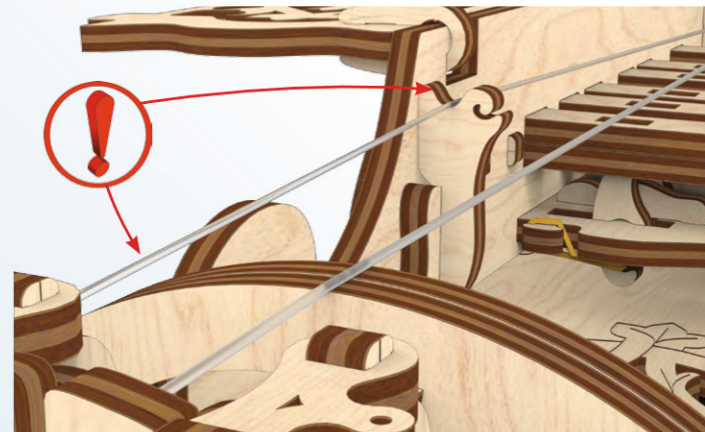

1

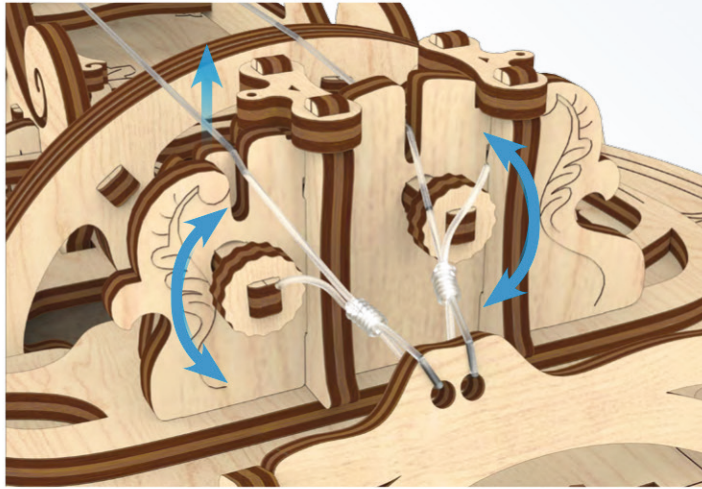

www.ugearsmodels.com/hurdy-gurdy

2

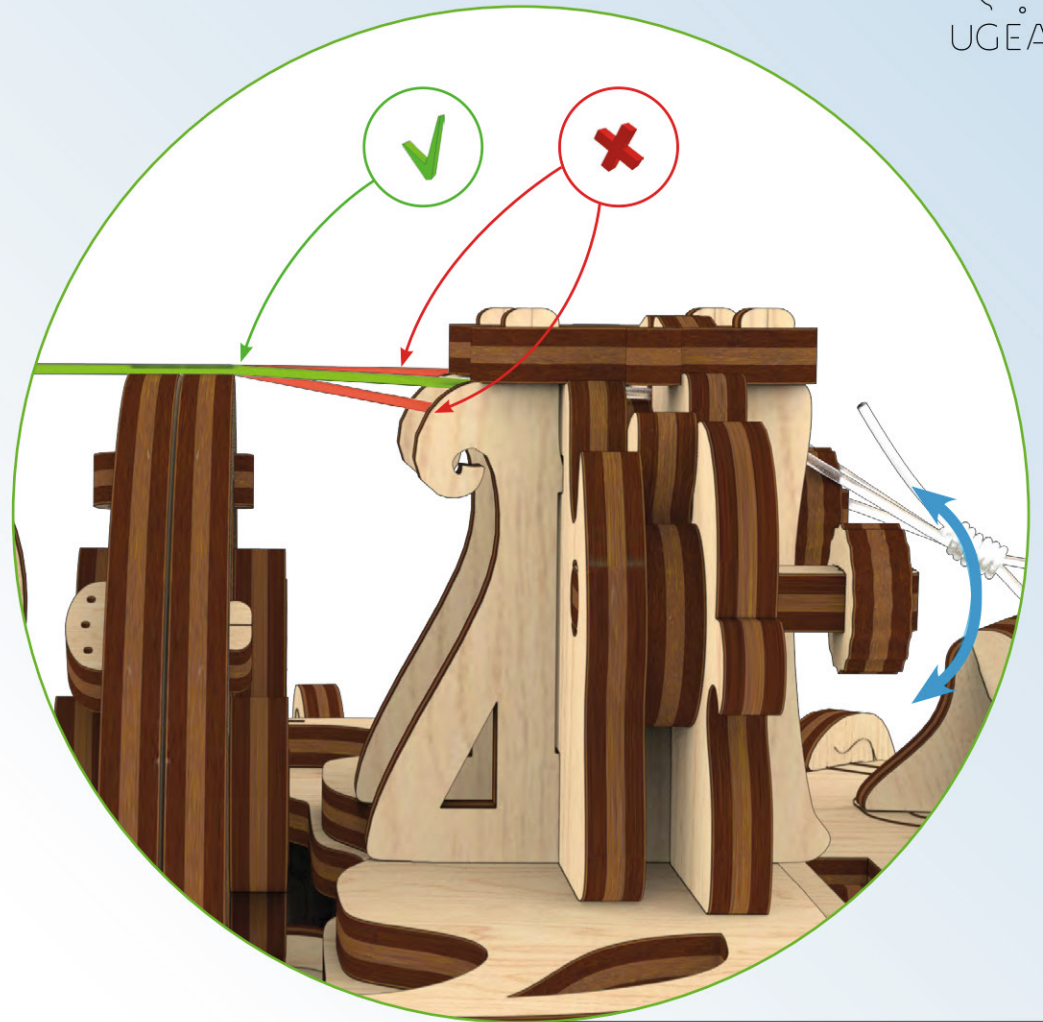
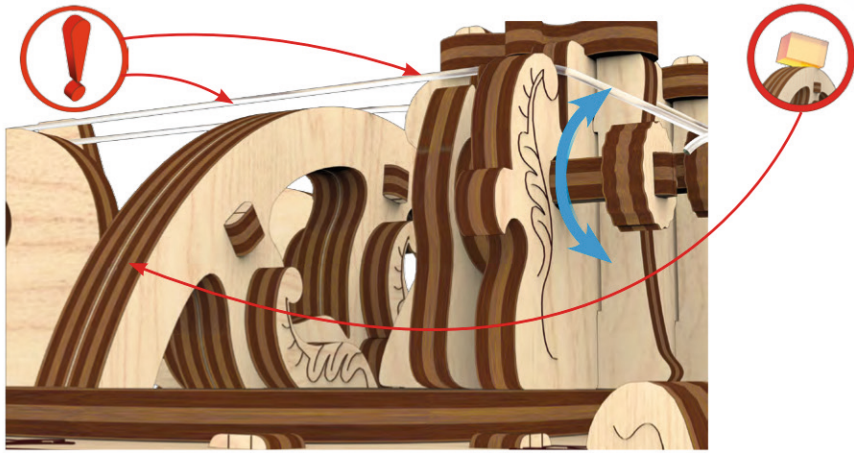

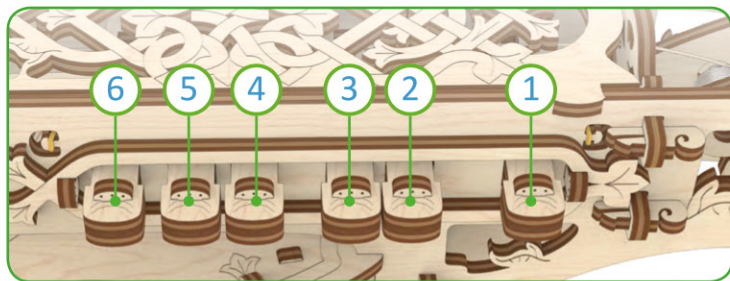
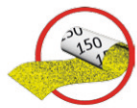

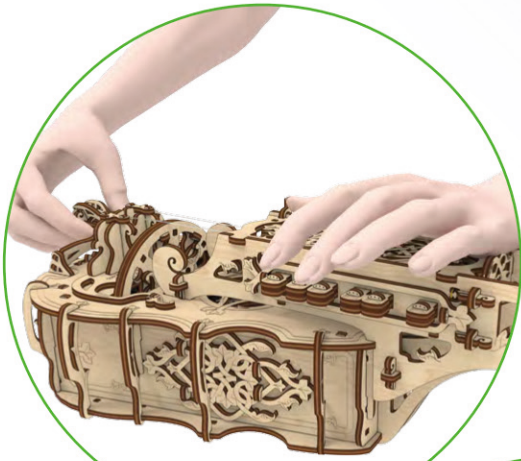

0



1

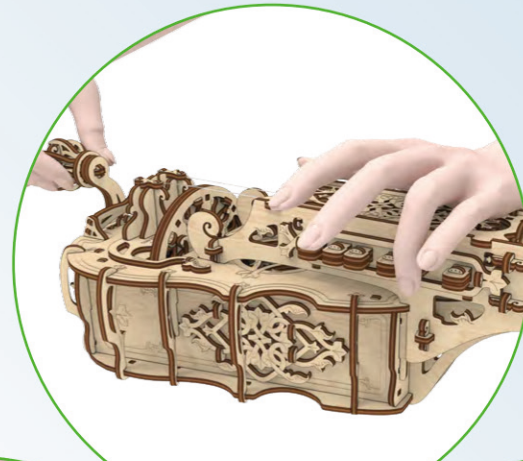

2



3



4

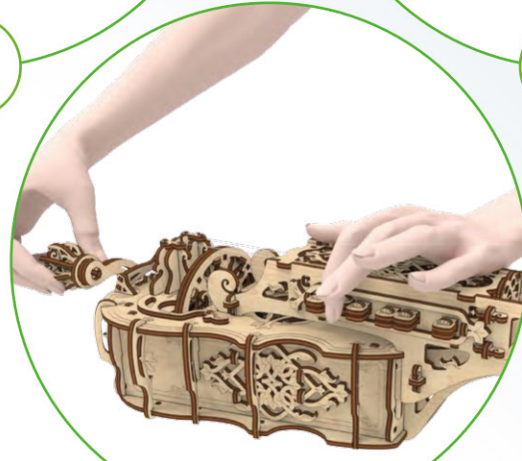

5



6



www.ugearsmodels.com/hurdy-gurdy

Ode to Joy

Musical notation for 'Ode to Joy' consisting of 26 notes. The notes are quarter notes with stems pointing up. The first two notes are beamed together. The last two notes are half notes. The notes are: C4, D4, E4, F4, G4, A4, B4, C5, C4, D4, E4, F4, G4, A4, B4, C5, C4, D4, E4, F4, G4, A4, B4, C5, C4, D4, E4, F4, G4, A4, B4, C5. Fingerings are: 2, 2, 3, 4, 4, 3, 2, 1, 0, 0, 1, 2, 2, 1, 2, 2, 3, 4, 4, 3, 2, 1, 0, 0, 1, 2, 1, 0. The piece ends with a repeat sign and a double bar line.

Branle des Sabots

Musical notation for 'Branle des Sabots' consisting of 26 notes. The notes are quarter notes with stems pointing up. The first two notes are beamed together. The next six notes are beamed together. The next two notes are beamed together. The next note is a quarter note. The next three notes are beamed together. The next note is a quarter note. The next six notes are beamed together. The notes are: C4, D4, E4, F4, G4, A4, B4, C5, C4, D4, E4, F4, G4, A4, B4, C5, C4, D4, E4, F4, G4, A4, B4, C5, C4, D4, E4, F4, G4, A4, B4, C5. Fingerings are: 3, 3, 4, 3, 2, 1, 2, 0, 1, 1, 0, 3, 3, 2, 3, 4, 3, 2, 1, 2, 0, 4, 3, 2, 1, 2, 0, 1, 1, 1, 1. The piece ends with a repeat sign and a double bar line.

Medieval Rock'n'Roll



5 4 3 2 3 3 5 5 4 3 | 5 4 3 2 4 4 2 0 | 5 4 3 2 3 3 5 5 4 3 |



5 4 3 2 3 3 1 3 3 2 3 | 4 3 5 3 6 6 5 4 | 5 5 4 3 4 4 3 0 |



4 3 5 3 6 6 5 4 | 1 3 3 2 3 | 5 5 4 3 4 4 3 0 | :



ENG Thanks for following along on this journey with us. UKR Дякуємо, що ви пройшли цей шлях з нами. DEU Vielen Dank, dass Sie diesen Weg mit uns gegangen sind. FRA Merci denous avoir accompagnés tout au long de ces étapes. POL Dziękujemy, że razem z nami pokonałeś tę drogę! SPA Gracias por haber recorrido el camino con nosotros. ITA Grazie per aver fatto uesto percorso con noi. TUR Bizimle bu yolu geçtiğiniz için teşekkür ederiz. RUS Спасибо, что вы прошли этот путь с нами. KOR UGEARS와 함께해 주셔서 감사합니다. CHI 感谢您参与有趣的模型配装过程。

ugearsmodels.com